



SunnyVal

Garden & contract





En **Sunnyval Garden & Contract**, nos enorgullece anunciar nuestra visión renovada y una misión reafirmada para liderar el camino en la industria del mobiliario de exterior, con el compromiso de elevar constantemente el estándar, con productos que no solo son sublimes sino también funcionales y duraderos.

Estamos encantados de presentar una nueva gama de productos que fusionan diseño y tecnología. Cómodas y versátiles piezas de descanso que son sinónimo de elegancia. Cada artículo de nuestro nuevo catálogo es una apuesta elegida minuciosamente para ofrecer la combinación perfecta de estilo y funcionalidad que caracteriza a nuestros clientes.

Un Nuevo Horizonte de Diseño Excepcional

Compartimos contigo nuestra última creación, colecciones que marcan un nuevo hito en el mundo de mobiliario de exterior. Hay numerosas maneras de buscar la belleza y alcanzar la excelencia, pero no todas son igualmente apropiadas. La nuestra está firmemente arraigada en la sostenibilidad y la responsabilidad social. Nos preocupamos por el medio ambiente, el bienestar de todos y un desarrollo económico consciente.



At **Sunnyval Garden & Contract**, we are proud to announce our renewed vision and reaffirmed mission to lead the way in the outdoor furniture industry, with a commitment to constantly raising the bar, with products that are not only sublime but also functional and durable. We are delighted to present a new range of products that fuse design and technology. Comfortable and versatile lounge pieces that are synonymous with elegance. Each item in our new catalog is a bet carefully chosen to offer the perfect combination of style and functionality that characterizes our customers.

A New Horizon of Exceptional Design

We share with you our latest creation, collections that mark a new milestone in the world of outdoor furniture. There are numerous ways to pursue beauty and achieve excellence, but not all are equally appropriate. Ours is firmly rooted in sustainability and social responsibility. We care about the environment, the well-being of all and conscious economic development.

SUNNYVAL MARCA REGISTRADA DE **COVAL S.A.**

Av. ESPIOCA Nº 85
46460 - SILLA
VALENCIA

+34 - 961 210 713
INFO@SUNNYVAL.EU
WWW.SUNNYVAL.EU

Año 2024





SunnyVal
Garden & contract





SUMARIO

ALUMINIO

ALUMINIUM 6-40

APOLO	6	ISABELLE	28
OMI	12	ANTARES	34
CONCEPT	16	NEW OSLO	40

CUERDA / TEXTIL

ROPE / TEXTILE 60-90

HADAR	62	DENEB	76
VIKEN	66	BORGEN	86
VEGA	74	L. ISLAND	90

TECA

TEAK 94-124

NIREA	96	VERNOM	116
JAVA	104	CLASSIC	124
EDSON	108		

FUNDAS PROTECCIÓN

PROTECTION COVERS 132-136

NOVEDAD / NEWEST

FOX	42	TANGO	50
BALI	46	SOBER	58

APOLO

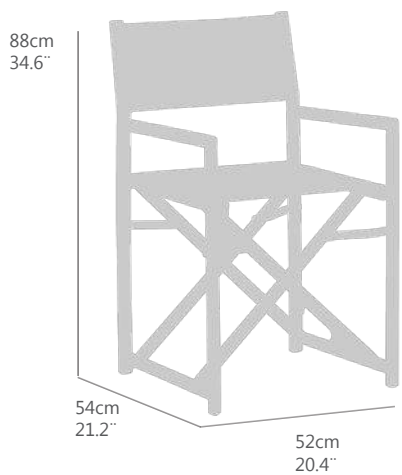

SILLÓN DIRECTOR CON BRAZOS.
 ESTRUCTURA EN ALUMINIO COLOR ANTRACITA O BLANCO
 TEXTILENE COLOR GRIS MEDIO.
 BRAZOS EN POLYWOOD COLOR TECA.
 ALTA RESISTENCIA A LA INTEMPERIE. PLEGABLE

Aa(cm)	sh(in)	Ab(cm)	ah(in)	Ae(cm)	fh(in)	PN(kg)	NW(lb)
45	17.7	63	24.8	88	34.6	4.4	7.7
Ptos (pt)							312

<p>Textilene</p>  <p>Gris medio SVTX6</p>	<p>Polywood</p>  <p>Teca SVPW02</p>
<p>Aluminio</p>  <p>Antracita SVAL4</p> <p>Ref.(code) 30200865</p>	<p>Aluminio</p>  <p>Blanco SVAL1</p> <p>Ref.(code) 30200854</p>

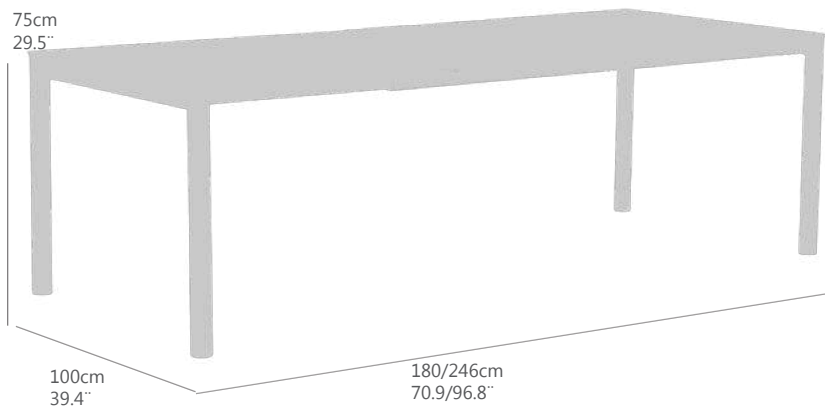

MESA RECTANGULAR EXTENSIBLE.
 ESTRUCTURA EN ALUMINIO COLOR ANTRACITA O BLANCO.
 ENCIMERA EN CRISTAL CERÁMICO DE 8MM. GRIS O BLANCO
 EXTENSIBLE EN HPL.
 ALTA RESISTENCIA A LA INTEMPERIE.
 REQUIERE MONTAJE.

GT(cm)	TT(in)	Al(cm)	FH(in)	PN(kg)	NW(LB)
8.0	3.14	68	26.8	80	176.4
Ptos (pt)					2214

<p>HPL</p>  <p>Teca SVPW02</p>	<p>Aluminio</p>  <p>Antracita SVAL4</p> <p>Ref.(code) 30200850</p>	<p>Cristal</p>  <p>Gris cerámico SVCT11</p>	<p>Aluminio</p>  <p>Blanco SVAL1</p> <p>Ref.(code) 30200861</p>	<p>Cristal</p>  <p>Ceram. Blanco SVCT14</p>
---	--	--	---	---



DETALLES / DETAILS
 138-140



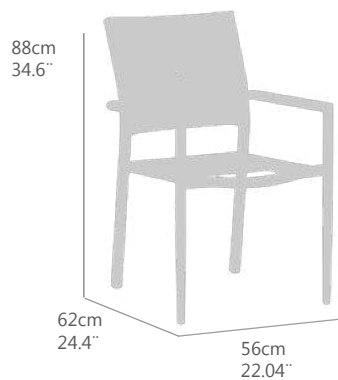
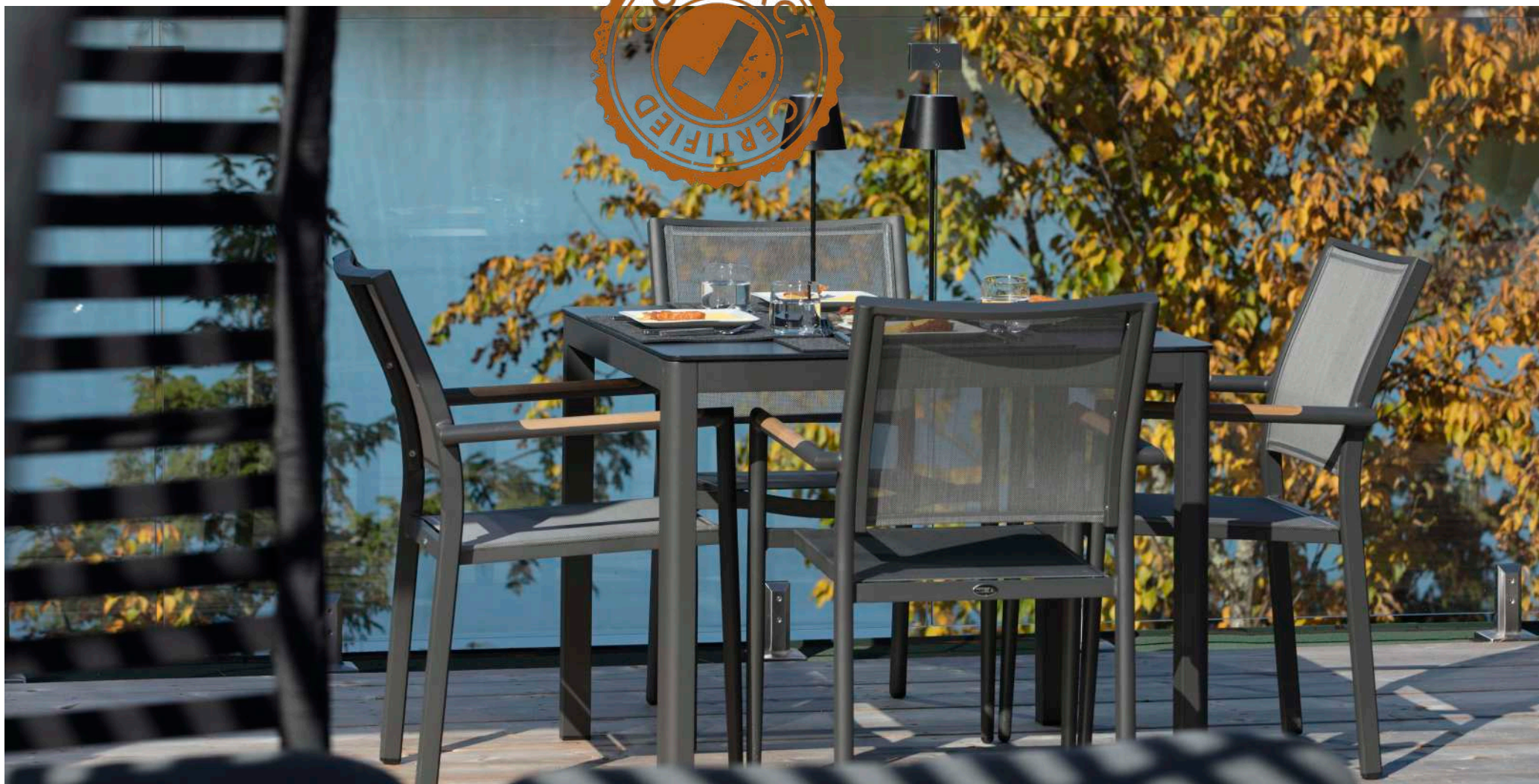

SILLÓN DE COMEDOR CON BRAZOS.
 ESTRUCTURA EN ALUMINIO COLOR **ANTRACITA** O **BLANCO**.
 TEXTILENE COLOR GRIS MEDIO.
 BRAZOS EN POLYWOOD COLOR TECA.
 ALTA RESISTENCIA A LA INTEMPERIE.
 APILABLE.

Aa(cm)	sh(in)	Ab(cm)	ah(in)	Ae(cm)	fh(in)	PN(kg)	NW(lb)
45	17.7	63	24.8	88	34.6	3.6	7.9
						Ptos (pt)	
						252	

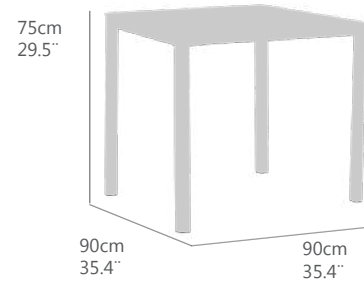
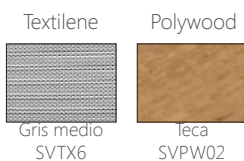

MESA DE COMEDOR CUADRADA
 ESTRUCTURA EN ALUMINIO COLOR **ANTRACITA** O **BLANCO**
 ENCIMERA EN CRISTAL CERÁMICO DE 8MM **GRIS** O **BLANCO**
 ALTA RESISTENCIA A LA INTEMPERIE.
 REQUIERE MONTAJE.

GT(cm)	TT(in)	Al(cm)	FH(in)	PN(kg)	NW(LB)
8.0	3.14	69	27.2	22	48.5
				Ptos (pt)	
				422	

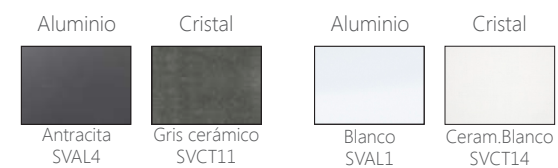

Ref.(code)
30200862

Ref.(code)
30200851

DETALLES / DETAILS
 138-140

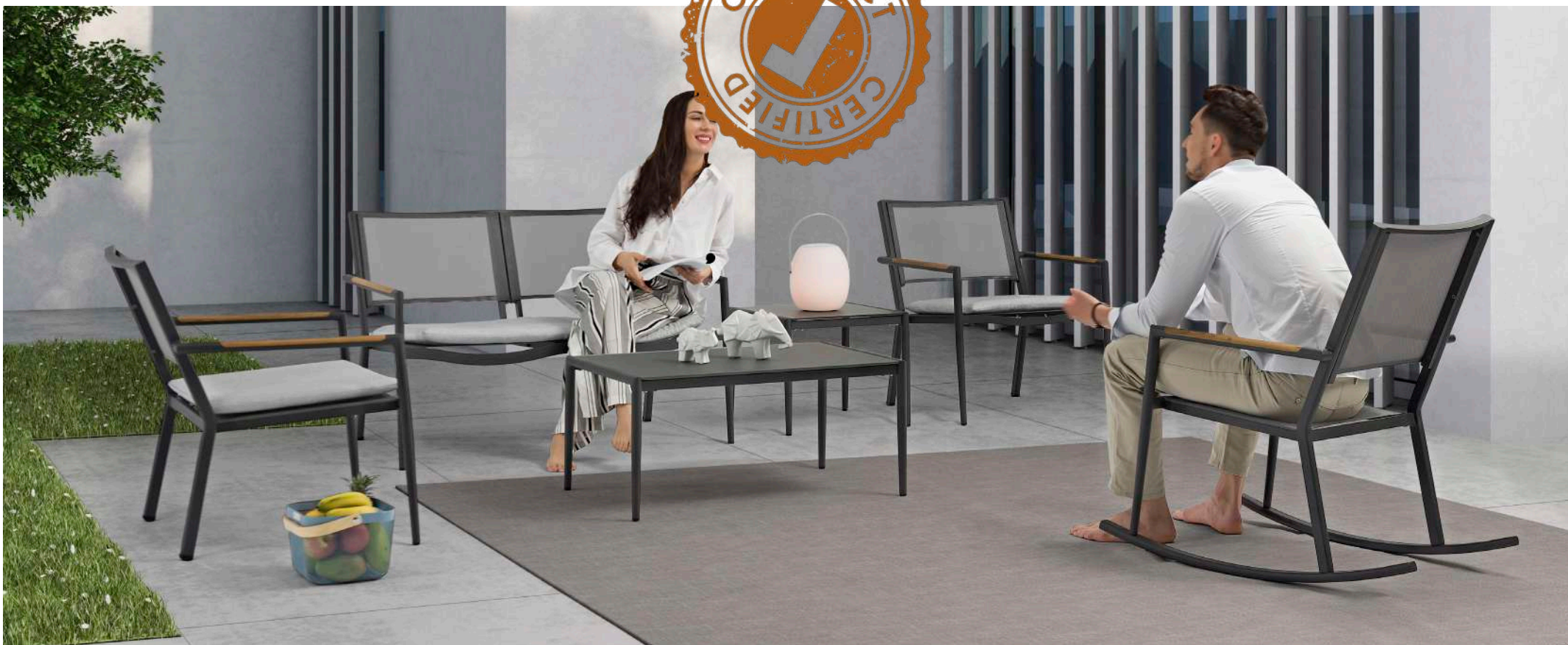

SILLÓN 1 PLAZA CON BRAZOS.
ESTRUCTURA EN ALUMINIO COLOR ANTRACITA O BLANCO.
TEXTILENE COLOR GRIS MEDIO.
BRAZOS EN POLYWOOD COLOR TECA.
ALTA RESISTENCIA A LA INTEMPERIE.
APILABLE.

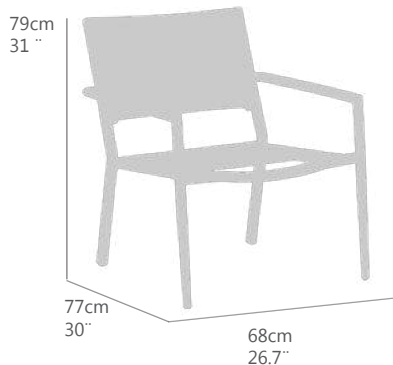

Aa(cm)	sh(in)	Ab(cm)	ah(in)	Ae(cm)	fh(in)	PN(kg)	NW(lb)
41	16.1	58	22.8	79	31.1	4.4	7.7
						Ptos (pt)	
						302	

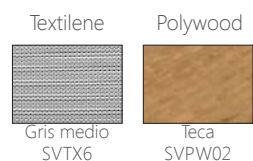

Ref.(code) **30200868** Ref.(code) **30200857**

SILLÓN balancín con brazos
ESTRUCTURA EN ALUMINIO COLOR ANTRACITA O BLANCO.
TEXTILENE COLOR GRIS MEDIO.
BRAZOS EN POLYWOOD COLOR TECA.
ALTA RESISTENCIA A LA INTEMPERIE.

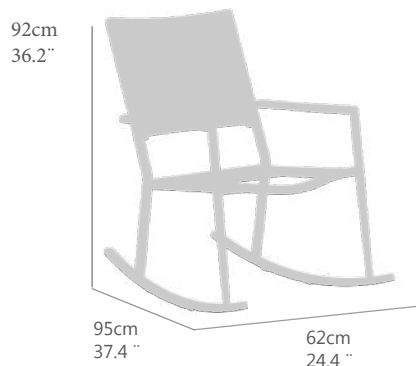

Aa(cm)	sh(in)	Ab(cm)	ah(in)	Ae(cm)	fh(in)	PN(kg)	NW(lb)
34/37	13.4/14.5	57	22.4	92	36.2	5.2	11.4
						Ptos (pt)	
						358	

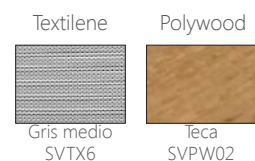

Ref.(code) **30200871** Ref.(code) **30200860**

MESA AUXILIAR RECTANGULAR
ESTRUCTURA EN ALUMINIO COLOR ANTRACITA O BLANCO
ENCIMERA EN CRISTAL CERÁMICO DE 8MM GRIS O BLANCO
ALTA RESISTENCIA A LA INTEMPERIE.
REQUIERE MONTAJE.

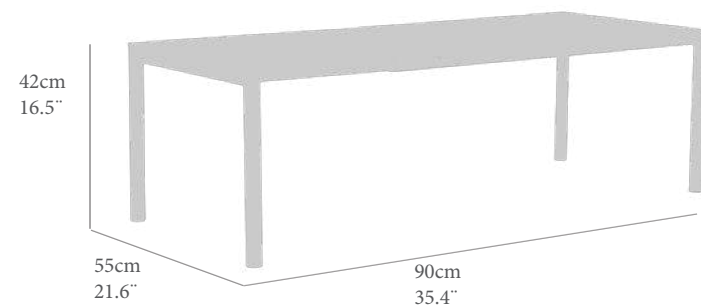

GT(cm)	TT(in)	Al(cm)	FH(in)	PN(kg)	NW(LB)
8.0	3.14	39	15.3	11	24.2
				Ptos (pt)	
				160	

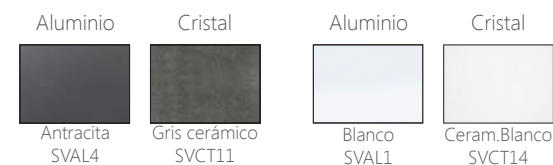

Ref.(code) **30200866**

Ref.(code) **30200855**

DETALLES / DETAILS
 138-140

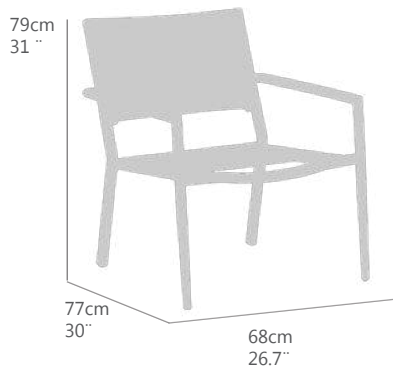

SILLÓN 1 PLAZA CON BRAZOS.
ESTRUCTURA EN ALUMINIO COLOR ANTRACITA o BLANCO.
TEXTILENE COLOR GRIS MEDIO.
BRAZOS EN POLYWOOD COLOR TEGA.
ALTA RESISTENCIA A LA INTEMPERIE.
APILABLE.

Aa(cm)	sh(in)	Ab(cm)	ah(in)	Ae(cm)	fh(in)	PN(kg)	NW(lb)
41	16.1	58	22.8	79	31.1	4.4	7.7
						Ptos (pt)	
						302	

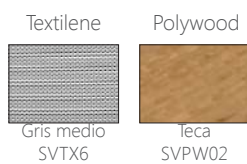

Ref.(code)
30200868

Ref.(code)
30200857

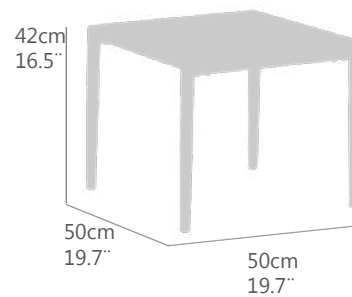

MESA AUXILIAR CUADRADA
ESTRUCTURA EN ALUMINIO COLOR ANTRACITA o BLANCO
ENCIMERA EN CRISTAL CERÁMICO DE 8MM GRIS o BLANCO
ALTA RESISTENCIA A LA INTEMPERIE.
REQUIERE MONTAJE.

GT(cm)	TT(in)	Al(cm)	FH(in)	PN(kg)	NW(LB)
8.0	3.14	39	15.3	6	13.2
				Ptos (pt)	
				160	

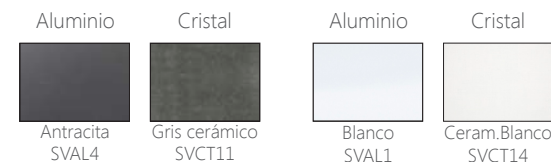

Ref.(code)
30200867

Ref.(code)
30200856

DETALLES / DETAILS
138-140

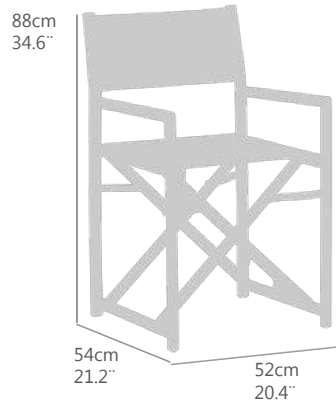

SIILLÓN DIRECTOR CON BRAZOS.
 ESTRUCTURA EN ALUMINIO COLOR **ANTRACITA** o **BLANCO**
 TEXTILENE COLOR GRIS MEDIO.
 BRAZOS EN POLYWOOD COLOR TECA.
 ALTA RESISTENCIA A LA INTEMPERIE. **P**LEGABLE

Aa(cm)	sh(in)	Ab(cm)	ah(in)	Ae(cm)	fh(in)	PN(kg)	NW(lb)
45	17.7	63	24.8	88	34.6	4.4	7.7
Ptos (pt)							
							312

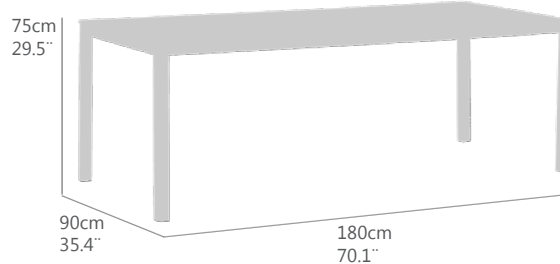
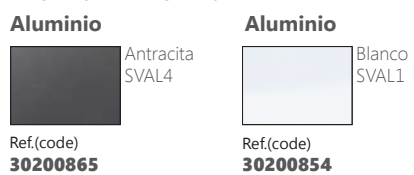
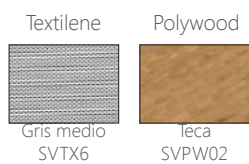

MESA DE COMEDOR RECTANGULAR.
 ESTRUCTURA EN ALUMINIO COLOR **ANTRACITA** o **BLANCO**
 ENCIMERA EN CRISTAL CERÁMICO DE 8 MM **GRIS** o **BLANCO**
 ALTA RESISTENCIA A LA INTEMPERIE.
 REQUIERE MONTAJE.

GT(cm)	TT(in)	Al(cm)	FH(in)	PN(kg)	NW(LB)
8.0	3.14	69	27.2	39.8	87.7
Ptos (pt)					
					756

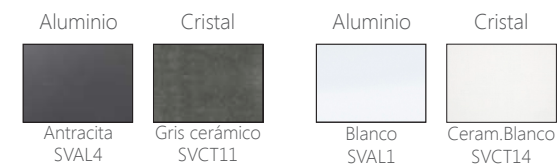

Ref.(code) **30200863** Ref.(code) **30200852**

DETALLES / DETAILS
 138-140

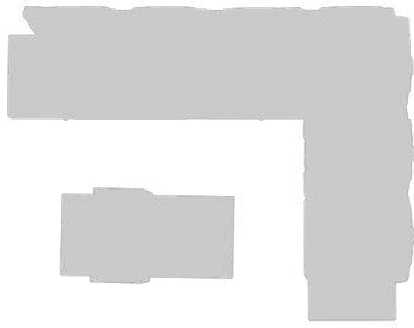

SET RINCONERA 3 PIEZAS.
 ESTRUCTURA EN ALUMINIO COLOR ANTRACITA
 COJINERIA COLOR BLANCO
 MADERA DE TECA.
 ALTA RESISTENCIA A LA INTEMPERIE.
 REQUIERE MONTAJE.

PN(kg)	NW(lb)	ref.(code)	ptos (pt)
102	224.4	30200785	3172

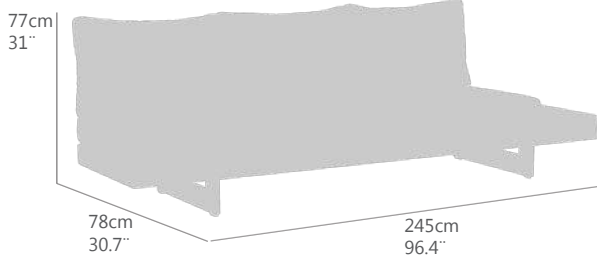

SOFA 3 PLAZAS
 ESTRUCTURA EN ALUMINIO COLOR ANTRACITA
 COJINERIA COLOR BLANCO
 CON DISPOSICION DE PLAZAS AJUSTABLE
 MADERA DE TECA
 ALTA RESISTENCIA A LA INTEMPERIE
 REQUIERE MONTAJE

Aa(cm)	sh(in)	Ab(cm)	ah(in)	Ae(cm)	fh(in)	PN(kg)	NW(lb)
37	14.6			71	27.9	40	88
						Ptos (pt)	
						1360	



Ref.(code)
30200797

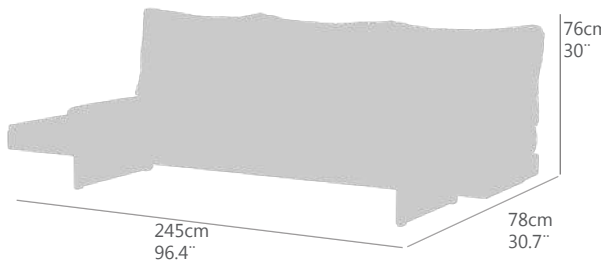

SOFA ESQUINERO
 ESTRUCTURA EN ALUMINIO COLOR ANTRACITA
 COJINERIA COLOR BLANCO
 CON DISPOSICION DE PLAZAS AJUSTABLE
 MADERA DE TECA
 ALTA RESISTENCIA A LA INTEMPERIE
 REQUIERE MONTAJE

Aa(cm)	sh(in)	Ab(cm)	ah(in)	Ae(cm)	fh(in)	PN(kg)	NW(lb)
37	14.6			71	27.9	40	88
						Ptos (pt)	
						1360	

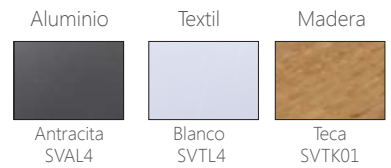

Ref.(code)
30200798

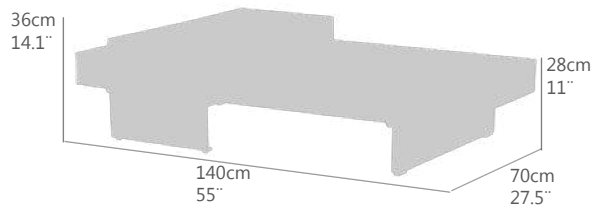

MESA DE CENTRO
 ESTRUCTURA EN ALUMINIO COLOR ANTRACITA
 ENCIMERA EN MADERA DE TECA
 MESA MOVIL SUPERIOR COLOR ANTRACITA
 ALTA RESISTENCIA A LA INTEMPERIE.

GT(cm)	TT(in)	Al(cm)	FH(in)	PN(kg)	NW(Lb)
2	0.7	18	7	22	48.4
					Ptos (pt)
					510



Ref.(code)
30200786





45/65 cm
17,7"/25,6"

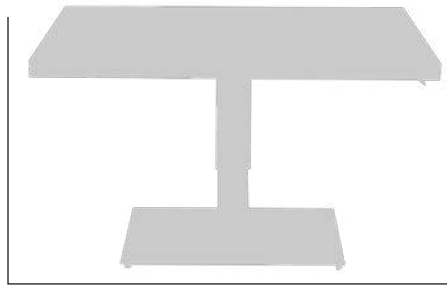

150 cm
59,0"

90 cm
35,4"

MESA AUXILIAR/COMEDOR CON MECANISMO AJUSTABLE
ESTRUCTURA EN ALUMINIO COLOR ANTRACITA
ENCIMERA DE MADERA FSC ACACIA
BASE DE ACERO: 1000x600-x8MM
ALTA RESISTENCIA A LA INTEMPERIE.
REQUIERE MONTAJE.

PN(kg)	NW(LB)
66	145,5
Ptos (pt)	
1137	

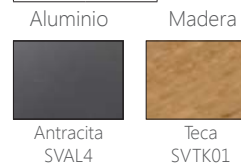

Ref.(code)
30200097

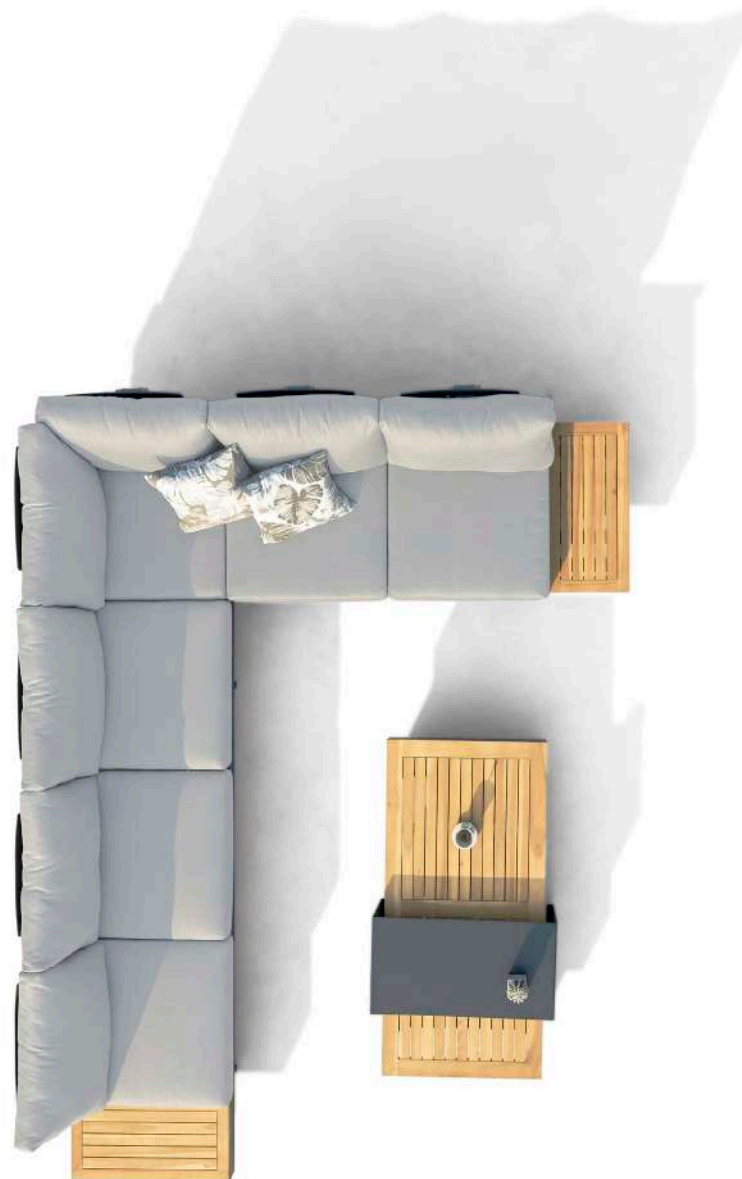

DETALLES / DETAILS

141



DETALLES / DETAILS
141

TUMBONA

ESTRUCTURA DE ALUMINIO Y TEXTILENE EN COLORES VARIADOS

RESPALDO REGULABLE EN 5 POSICIONES

RUEDAS DE TRANSPORTE OCULTAS

APILABLE

Aa(cm)	sh(in)	Ab(cm)	ah(in)	Ae(cm)	fh(in)	PN(kg)	NW(lb)
31,0	12,2	31/95	12,2/37,4			12,5	27,6
						Ptos (pt)	
						520	

Aluminio	Textilene	Ref.(code) 30200314
		
Blanco SVAL1	Blanco SVTX1	
Aluminio	Textilene	Ref.(code) 30200308
		
Blanco SVAL1	taupe SVTX5	
Aluminio	Textilene	Ref.(code) 30200376
		
Antracita SVAL4	Antracita SVTX4	
Aluminio	Textilene	Ref.(code) 30200373
		
Blanco SVAL1	Gris claro SVTX2	

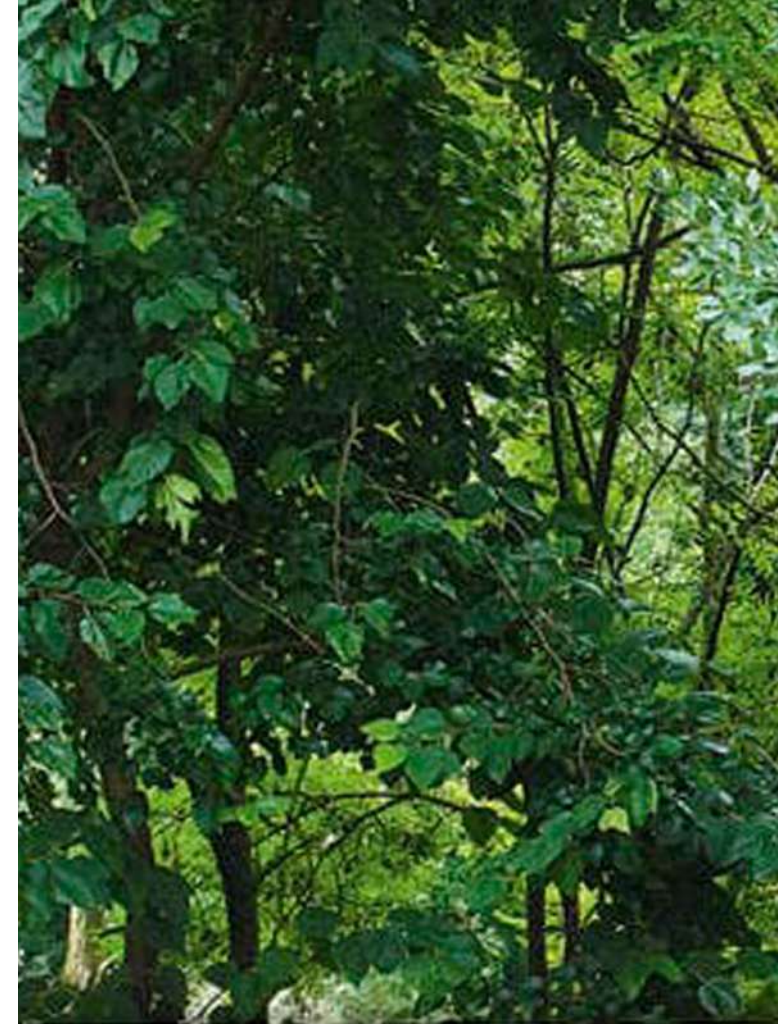





DETALLES / DETAILS

143-151

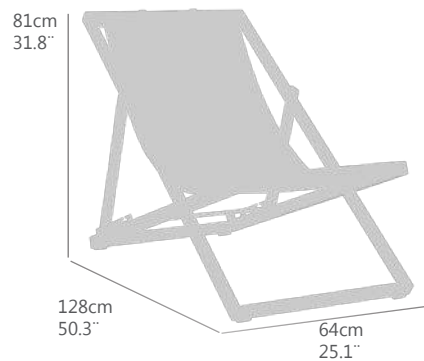

TUMBONA PLEGABLE MODELO BOSTON
 BASE DE ALUMINIO Y TEXTILENE EN DIFERENTES COLORES
 RESPALDO REGULABLE MULTIPOSICION.

Aa(cm)	sh(in)	Ar(cm)	Bh(in)	Ab(cm)	Aa(in)	PN(kg)	NW(lb)
32-39,5	12,6-15,5	63/81	24,8/31,9			5,9	13,0
						Ptos (pt)	
						240	

Aluminio	Textilene	Ref.(code) 30200312
		
Blanco SVAL1	Blanco SVTX1	

Aluminio	Textilene	Ref.(code) 30200385
		
Blanco SVAL1	Gris claro SVTX2	

Aluminio	Textilene	Ref.(code) 30200311
		
Blanco SVAL1	Taupe SVTX5	

Aluminio	Textilene	Ref.(code) 30200387
		
Taupe SVAL3	Taupe SVTX5	

Aluminio	Textilene	Ref.(code) 30200388
		
Antracita SVAL4	Antracita SVTX4	



DETALLES / DETAILS
 143-151

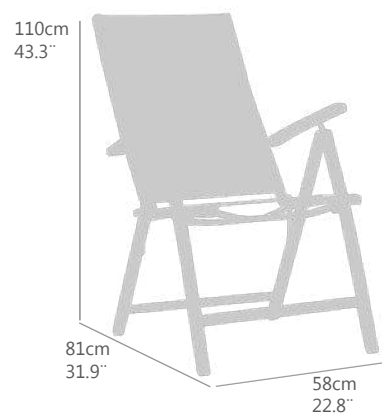

SILLÓN MULTIPOSICIÓN

ALUMINIO Y TEXTILENE EN DIVERSOS COLORES

RESPALDO REGULABLE EN 5 POSICIONES

PLEGABLE Y DE GRAN RESISTENCIA A LA INTEMPERIE

Aa(cm)	sh(in)	Ar(cm)	Bh(in)	Ab(cm)	Aa(in)	PN(kg)	NW(lb)
47,5	18,7	98-113	38,6/44,5	74,0	29,1	5,5	12,1
Ptos (pt)							
							212

Aluminio	Textilene	
		Ref.(code) 30200268
Blanco SVAL1	Blanco SVTX1	
Aluminio	Textilene	
		Ref.(code) 30200269
Blanco SVAL1	taupe SVTX5	
Aluminio	Textilene	
		Ref.(code) 30200413
Antracita SVAL4	Antracita SVTX4	
Aluminio	Textilene	
		Ref.(code) 30200271
Blanco SVAL1	Gris claro SVTX2	

SILLA CON BRAZOS

ALUMINIO Y TEXTILENE EN DIVERSOS COLORES

APILABLE

GRAN RESISTENCIA A LA INTEMPERIE

Aa(cm)	sh(in)	Ab(cm)	Ah(in)	Ae(cm)	Fh(in)	PN(kg)	NW(lb)
46,0	18,1	65,6	25,8	86,0	33,9	3,3	7,3
Ptos (pt)							
							118

Aluminio	Textilene	
		Ref.(code) 30200309
Blanco SVAL1	Blanco SVTX1	
Aluminio	Textilene	
		Ref.(code) 30200301
Blanco SVAL1	taupe SVTX5	
Aluminio	Textilene	
		Ref.(code) 30200291
Antracita SVAL4	Antracita SVTX4	
Aluminio	Textilene	
		Ref.(code) 30200360
Blanco SVAL1	Gris claro SVTX2	

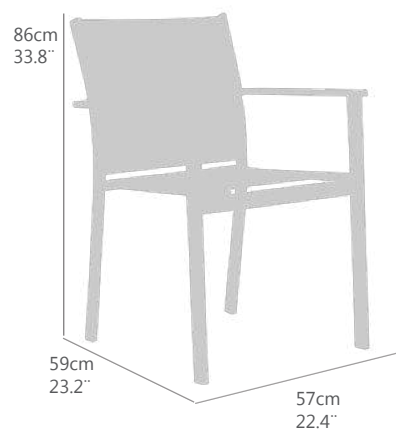

DETALLES / DETAILS
143-151

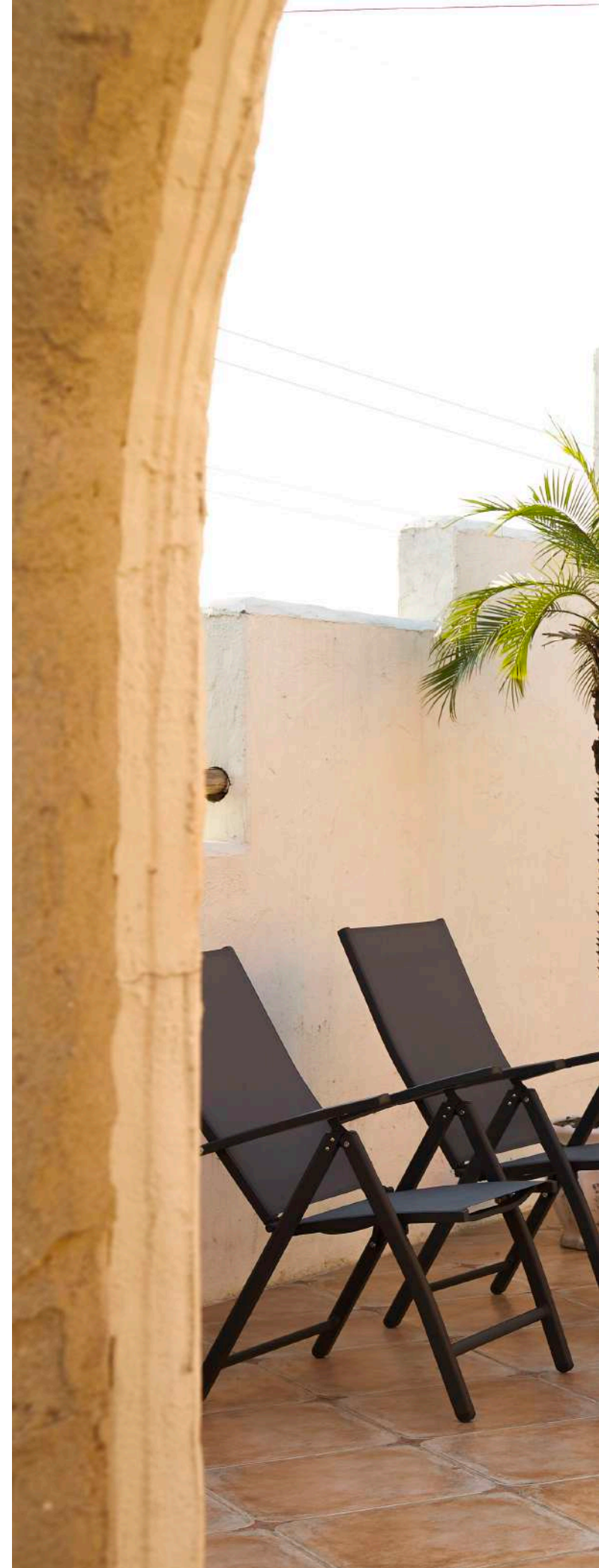





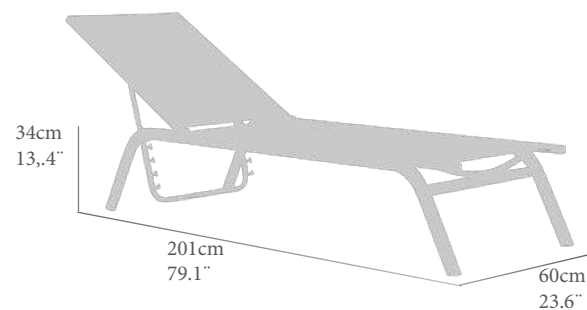



TUMBONA MODELO ATENA

ESTRUCTURA DE ALUMINIO Y TEXTILENE DE DIVERSOS COLORES

RESPALDO REGULABLE EN 5 POSICIONES

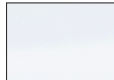

APILABLE.



Aa(cm)	sh(in)	Ar(cm)	Bh(in)	Ab(cm)	Aa(in)	PN(kg)	NW(lb)
34,0	13,4	34/101	13,4/39,8			6,7	14,8
						Ptos (pt)	
						220	

Aluminio	Textilene	
		Ref.(code) 30200377
Blanco SVAL1	Blanco SVTX1	

Aluminio	Textilene	
		Ref.(code) 30200380
Blanco SVAL1	Gris claro SVTX2	

Aluminio	Textilene	
		Ref.(code) 30200378
Blanco SVAL1	taupe SVTX5	

Aluminio	Textilene	
		Ref.(code) 30200382
taupe SVAL3	taupe SVTX5	

Aluminio	Textilene	
		Ref.(code) 30200383
Antracita SVAL4	Antracita SVTX4	



DETALLES / DETAILS
143-151





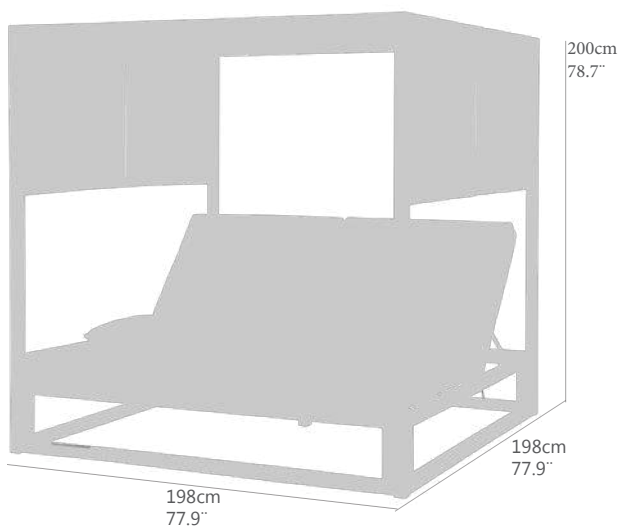

Aa(cm)	sh(in)	Ar(cm)	Bh(in)	Ab(cm)	Aa(in)	PN(kg)	NW(lb)
34,0	13,4	34/101	13,4/39,8			63,0	138,9

DAYBED MODELO CONCEPT

ESTRUCTURA DE ALUMINIO PINTADA EN COLOR BLANCO

RESPALDO CON DOS ZONAS REGULACIÓN INDEPENDIENTES

CUBIERTA SUPERIOR CON REGULACIÓN LATERAL EN POLIESTER REFORZADO CON TEFLÓN

TERMINACIÓN DEL COLCHÓN EN POLIPIEL NÁUTICA Y TEXTILENE EN LA PARTE INFERIOR PARA UNA FÁCIL EVACUACIÓN

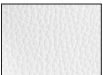
Aluminio	Polipiel	Ref.(code) 30200225
		
Blanco SVAL1	Nautico blanco SVTL1	Ptos (pt) 2100

DAYBED MODELO CONCEPT EXCLUSIVE

ESTRUCTURA DE ALUMINIO PINTADA EN COLOR ANTRACITA O TAUPE

RESPALDO CON DOS ZONAS REGULACIÓN INDEPENDIENTES

CUBIERTA SUPERIOR CON REGULACIÓN LATERAL EN POLIESTER REFORZADO CON TEFLÓN

COLCHÓN EN TELA ACRILICA DE ALTA CALIDAD CON ALTA CAPACIDAD DEL EVACUACIÓN. Y GROSOR DE 12CM COLORES ANTRACITA O TAUPE

Aluminio	Textil	Ref.(code) 33000003
		
Taupe SVAL3	Taupe CARTENZA	Ptos (pt) 2858

Aluminio	Textil	Ref.(code) 33000005
		
Antracita SVAL4	Gris CARTENZA	Ptos (pt) 2858

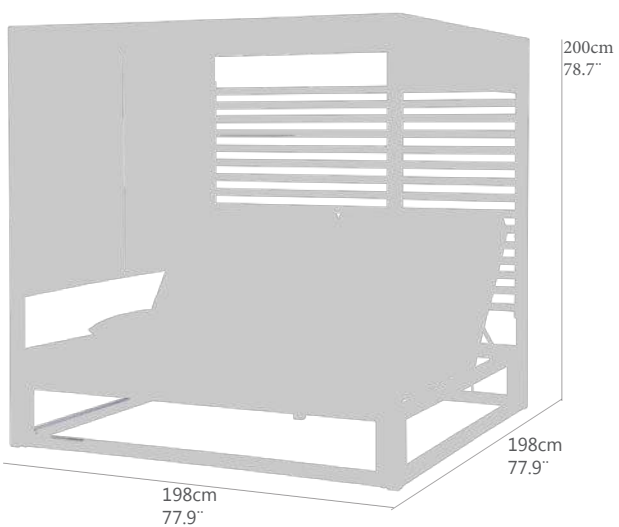

Aa(cm)	sh(in)	Ar(cm)	Bh(in)	Ab(cm)	Aa(in)	PN(kg)	NW(lb)
34,0	13,4	34/101	13,4/39,8			78,0	172,0

DAYBED MODELO CONCEPT STYLE

ESTRUCTURA DE ALUMINIO PINTADA EN COLOR BLANCO

TRASERA CON KIT DE REDUCCIÓN SOLAR

RESPALDO CON DOS ZONAS REGULACIÓN INDEPENDIENTES

CUBIERTA SUPERIOR CON REGULACIÓN LATERAL EN TELA ACRÍLICA

COLCHÓN EN POLIPIEL NÁUTICA CON GROSOR DE 12 CM. SISTEMA INFERIOR DE DRENAJE Y TRANSPIRACIÓN

DESENFUNDABLE COJINES AUXILIARES INCLUIDOS

Aluminio	Polipiel	Ref.(code) 33000010
		
Blanco SVAL1	Nautico blanco SVTL1	Ptos (pt) 2480

DAYBED MODELO CONCEPT STYLE

ESTRUCTURA DE ALUMINIO PINTADA EN COLOR ANTRACITA O TAUPE

TRASERA CON KIT DE REDUCCIÓN SOLAR

RESPALDO CON DOS ZONAS REGULACIÓN INDEPENDIENTES

CUBIERTA SUPERIOR CON REGULACIÓN LATERAL EN TELA ACRÍLICA

COLCHÓN EN POLIPIEL NÁUTICA CON GROSOR DE 12 CM. SISTEMA INFERIOR DE DRENAJE Y TRANSPIRACIÓN

DESENFUNDABLE COJINES AUXILIARES INCLUIDOS

Aluminio	Textil	Ref.(code) 33000030
		
Taupe SVAL3	Taupe CARTENZA	Ptos (pt) 3258

Aluminio	Textil	Ref.(code) 33000035
		
Antracita SVAL4	Gris CARTENZA	Ptos (pt) 3258





ISABELLE

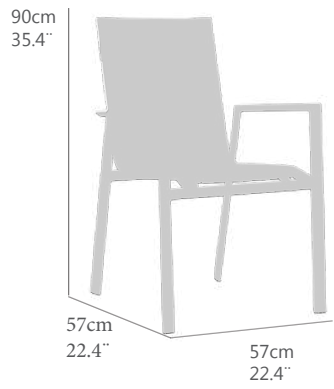

SILLA DE COMEDOR CON BRAZOS ISABELLE
 ESTRUCTURA EN ALUMINIO COLOR BLANCO O TAUPE Y TEXTILENE DE DOBLE
 PARED CON QUICK DRY FOAM COLOR GRIS CLARO O TAUPE
 ALTA RESISTENCIA A LA INTEMPERIE
 APILABLE.

Aa(cm)	sh(in)	Ab(cm)	Ah(in)	Ae(cm)	Fh(in)	PN(kg)	NW(lb)	
42,0	16,5	64,0	25,2	90	35,4	4,0	8,8	
							Ptos (pt)	
							118	

Aluminio	Textilene	
		Ref.(code) 30200683
Blanco SVAL1	Gris claro SVTX2	
Aluminio	Textilene	
		Ref.(code) 30200684
Taupe SVAL3	Taupe SVTX5	





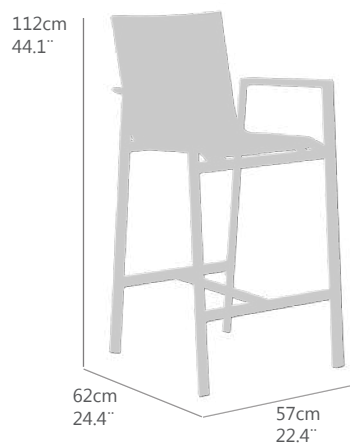

TABURETE ALTO CON BRAZOS ISABELLE
ESTRUCTURA EN ALUMINIO Y TEXTILENE DE DOBLE PARED CON QUICK DRY

FOAM

EN DOS COLORES

ALTA RESISTENCIA A LA INTEMPERIE.

APILABLE.

Aa(cm)	sh(in)	Ab(cm)	Ah(in)	Ae(cm)	Fh(in)	PN(kg)	NW(lb)
70,5	27,8	91,8	36,1	112	44,1	5,1	11,2
Ptos (pt)							
196							

Aluminio Textilene



Ref.(code)
30200689

Aluminio Textilene

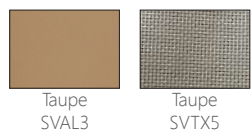

Ref.(code)
30200690

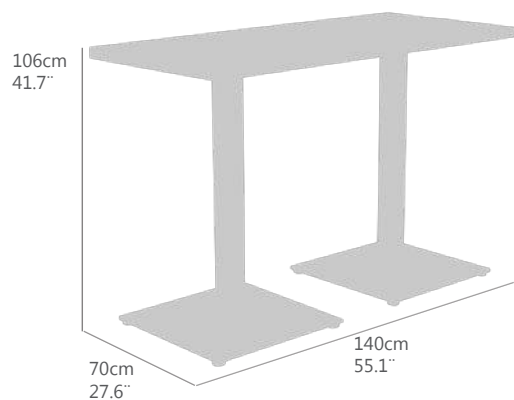

MESA ALTA RECTANGULAR ISABELLE
ESTRUCTURA Y TOP DE ALUMINIO

GT(cm)	TT(in)	Al(cm)	FH(in)	PN(kg)	NW(LB)
4,0	1,6	102	40,2	49,8	109,8
Ptos (pt)					
676					

Aluminio

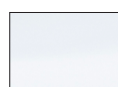

Ref.(code)
30200693

Aluminio

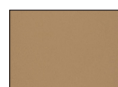

Ref.(code)
30200694



DETALLES / DETAILS
 158-159



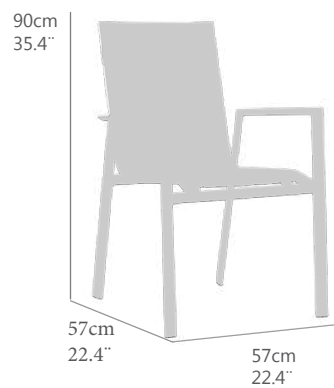

SILLA DE COMEDOR CON BRAZOS ISABELLE
 ESTRUCTURA EN ALUMINIO COLOR BLANCO O TAUPE Y TEXTILENE DE DOBLE
 PARED CON QUICK DRY FOAM COLOR GRIS CLARO O TAUPE
 ALTA RESISTENCIA A LA INTEMPERIE
 APILABLE.

Aa(cm)	sh(in)	Ab(cm)	Ah(in)	Ae(cm)	Fh(in)	PN(kg)	NW(lb)
42,0	16,5	64,0	25,2	90	35,4	4,0	8,8
Ptos (pt)							118

Aluminio	Textilene	Ref.(code) 30200683
		
Blanco SVAL1	Gris claro SVTX2	
Aluminio	Textilene	Ref.(code) 30200684
		
Taupe SVAL3	Taupe SVTX5	

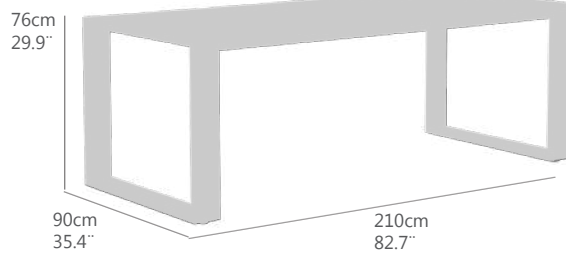

MESA DE COMEDOR RECTANGULAR ISABELLE
 ESTRUCTURA DE ALUMINIO COLOR BLANCO O TAUPE
 ENCIMERA EN CRISTAL CERÁMICO DE ALTA DURABILIDAD CON ACABADO
 "SKY GREY" O "GALAXY GRANIT"
 REQUIERE MONTAJE

GT(cm)	TT(in)	Al(cm)	FH(in)	PN(kg)	NW(lb)
0,8	0,3	71,0	28	51,0	112,4
Ptos (pt)					1258

Aluminio	Cristal	Ref.(code) 30200680
		
Blanco SVAL1	Sky grey	
Aluminio	Cristal	Ref.(code) 30200681
		
Taupe SVAL3	Galaxy granit	

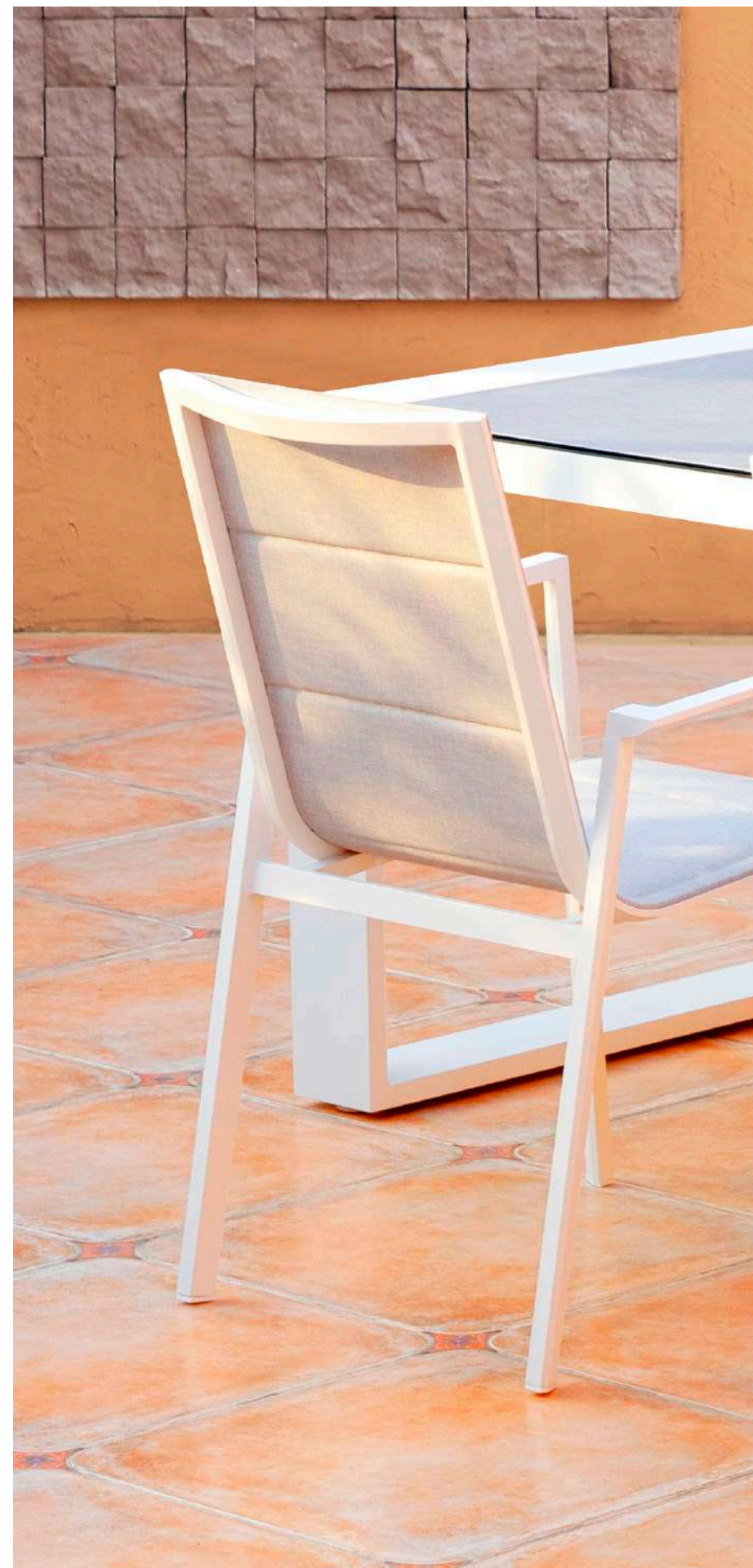

DETALLES / DETAILS
 158-159



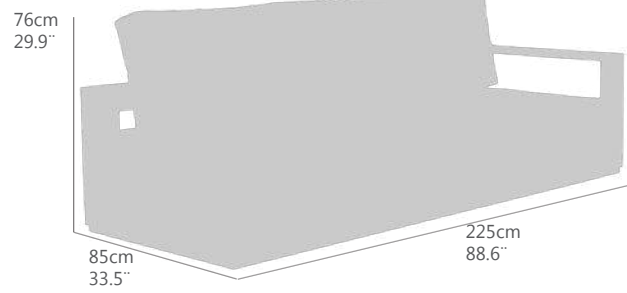

SOFÁ DE 3 PLAZAS MODELO **ANTARES**
 ESTRUCTURA EN ALUMINIO COLOR **ANTRACITA**
 COJIN DE ASIENTO Y RESPALDO COLOR **GRIS TEMPO**
 COJIN DE ASIENTO DE 15CM
 COJIN DE RESPALDO DE 15CM.
WATERPROOF

Aa(cm)	sh(in)	Ab(cm)	Ah(in)	Ae(cm)	Fh(in)	PN(kg)	NW(lb)
33,5	13,2	54,0	21,3	54,0	21,3	54,2	119,7
Ptos (pt)							
							1534

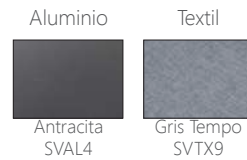

Ref.(code)
30200564

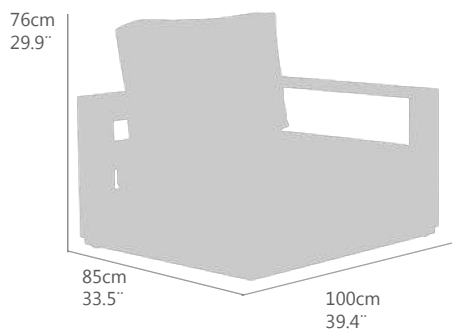

SOFÁ DE 1 PLAZA MODELO **ANTARES**
 ESTRUCTURA EN ALUMINIO COLOR **ANTRACITA**
 COJIN DE ASIENTO Y RESPALDO COLOR **GRIS TEMPO**
 COJIN DE ASIENTO DE 15CM.
 COJIN DE RESPALDO DE 15CM.
WATERPROOF.

Aa(cm)	sh(in)	Ab(cm)	Ah(in)	Ae(cm)	Fh(in)	PN(kg)	NW(lb)
33,5	13,2	54,0	21,3	54,0	21,3	28,0	61,8
Ptos (pt)							
							826

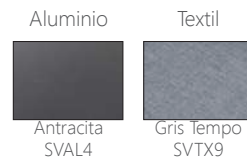

Ref.(code)
30200563

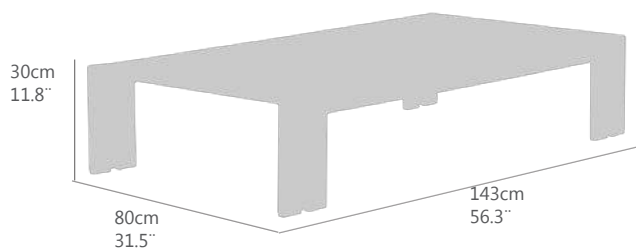

MESA AUXILIAR MODELO **ANTARES**
 ESTRUCTURA DE ALUMINIO COLOR **ANTRACITA** Y TOP EN LAMAS DE ALUMINIO COLOR **ANTRACITA**

GT(cm)	TT(in)	Al(cm)	FH(in)	PN(kg)	NW(lb)
0,3	0,1	27,5	10,8	13,9	30,7
Ptos (pt)					
					448



Ref.(code)
30200565





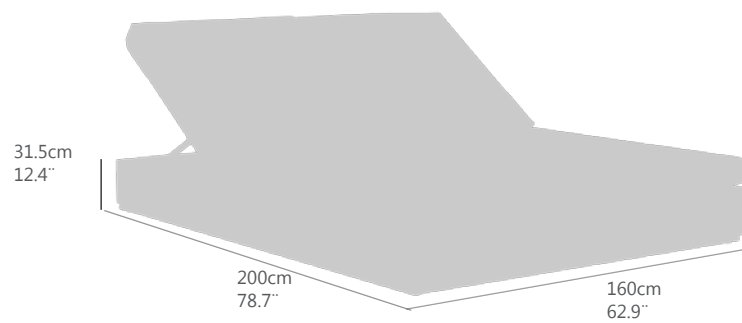

DAYBED MODELO **ANTARES**
 ESTRUCTURA EN ALUMINIO COLOR **ANTRACITA**
 COJIN DE ASIENTO Y RESPALDO COLOR **GRIS TEMPO**
 COJIN WATERPROOF DE 10CM.
 RUEDAS DE TRANSPORTE INCLUIDAS

Aa(cm)	sh(in)	Ar(cm)	Bh(in)	Ab(cm)	Aa(in)	PN(kg)	NW(lb)
31,5	12,4	31/79	12,4/31,3			31,4	69,3
						Ptos (pt)	
						1534	

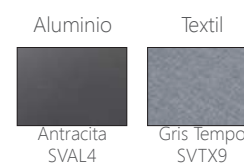

Ref.(code)
30200571

DETALLES / DETAILS
 160-161



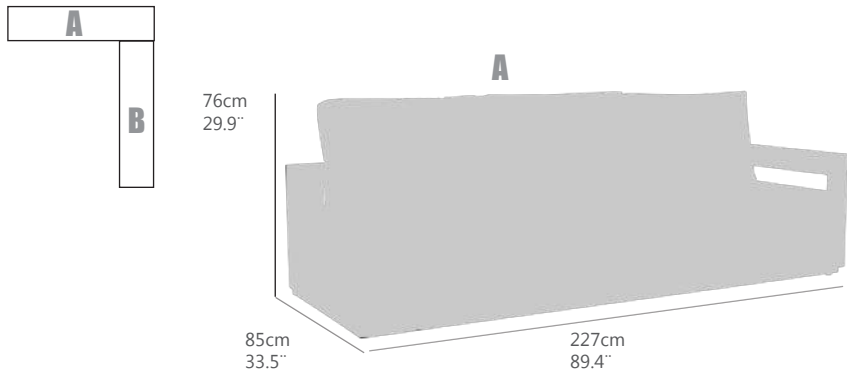

MODULO LOUNGE BRAZO DERECHO ANTARES
 ESTRUCTURA EN ALUMINIO COLOR ANTRACITA
 COJIN DE ASIENTO Y RESPALDO COLOR GRIS TEMPO
 COJIN DE ASIENTO DE 15CM.
 COJIN DE RESPALDO DE 15CM.
 WATERPROOF.

Aa(cm)	sh(in)	Ab(cm)	Ah(in)	Ae(cm)	Fh(in)	PN(kg)	NW(lb)
33,5	13,2	54,0	21,3	54,0	21,3	50,3	111,1
Ptos (pt)							1630

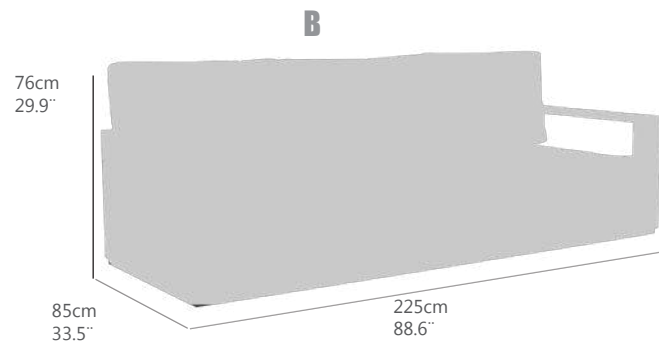

MODULO 3 PLAZAS BRAZO IZQUIERDO ANTARES
 ESTRUCTURA EN ALUMINIO COLOR ANTRACITA
 COJIN DE ASIENTO Y RESPALDO COLOR GRIS TEMPO
 COJIN DE ASIENTO DE 15CM.
 COJIN DE RESPALDO DE 15CM.
 WATERPROOF.

Aa(cm)	sh(in)	Ab(cm)	Ah(in)	Ae(cm)	Fh(in)	PN(kg)	NW(lb)
33,5	13,2	54,0	21,3	54,0	21,3	48,3	106,6
Ptos (pt)							1710

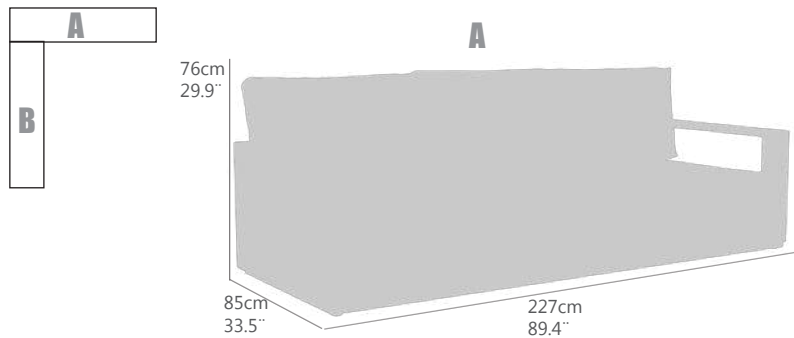

MODULO LOUNGE BRAZO IZQUIERDO ANTARES
 ESTRUCTURA EN ALUMINIO COLOR ANTRACITA
 COJIN DE ASIENTO Y RESPALDO COLOR GRIS TEMPO
 COJIN DE ASIENTO DE 15CM.
 COJIN DE RESPALDO DE 15CM.
 WATERPROOF.

Aa(cm)	sh(in)	Ab(cm)	Ah(in)	Ae(cm)	Fh(in)	PN(kg)	NW(lb)
33,5	13,2	54,0	21,3	54,0	21,3	50,3	111,1
Ptos (pt)							1630

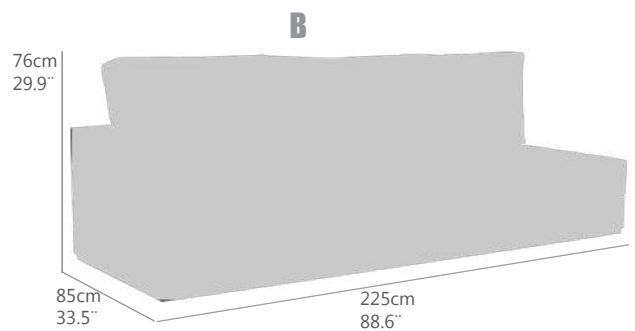

MODULO 3 PLAZAS BRAZO DERECHO ANTARES
 ESTRUCTURA EN ALUMINIO COLOR ANTRACITA
 COJIN DE ASIENTO Y RESPALDO COLOR GRIS TEMPO
 COJIN DE ASIENTO DE 15CM.
 COJIN DE RESPALDO DE 15CM.
 WATERPROOF.

Aa(cm)	sh(in)	Ab(cm)	Ah(in)	Ae(cm)	Fh(in)	PN(kg)	NW(lb)
33,5	13,2	54,0	21,3	54,0	21,3	48,3	106,6
Ptos (pt)							1710



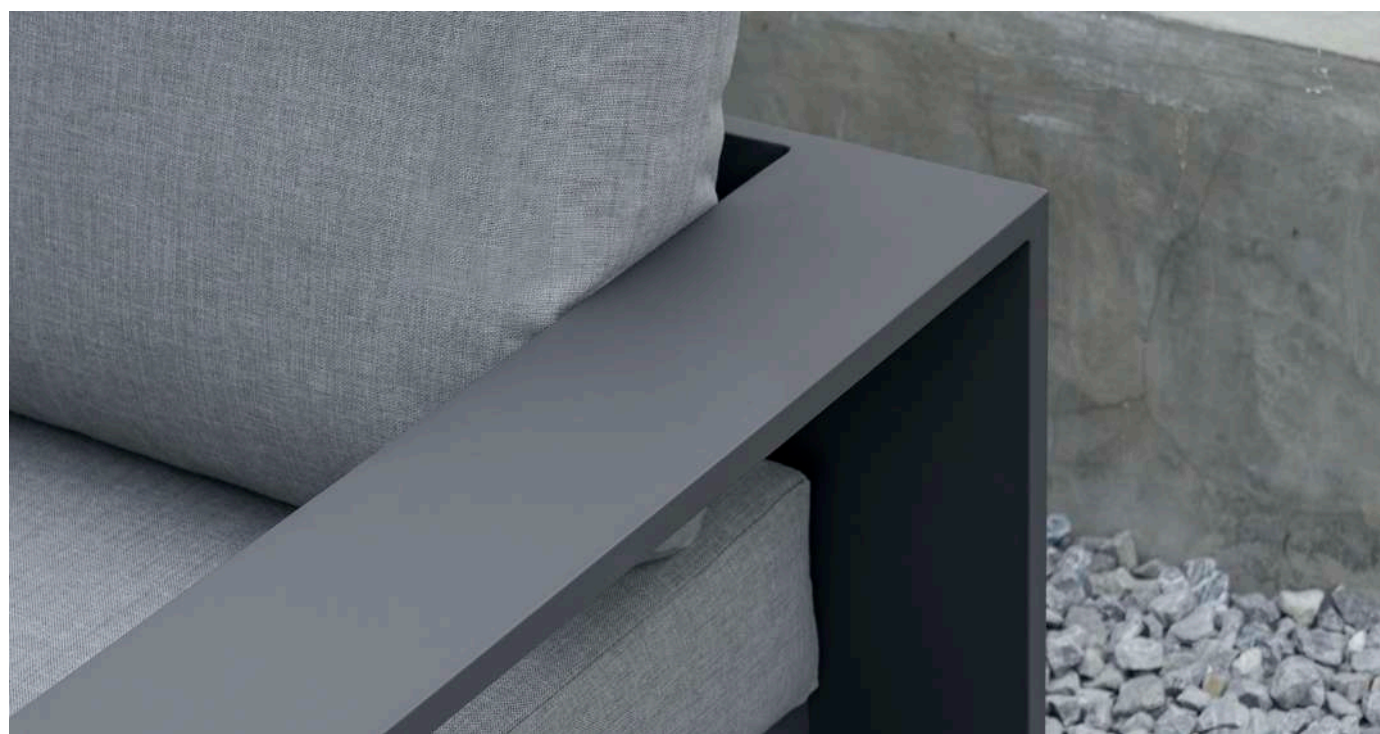

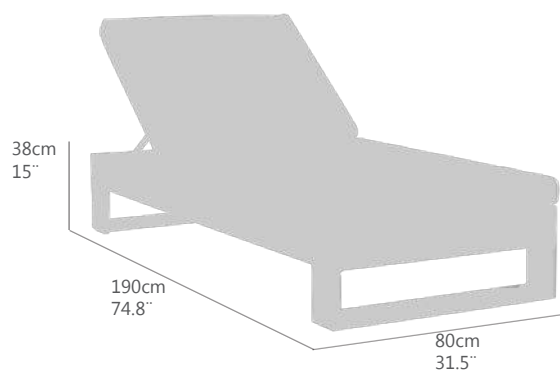

TUMBONA DE 1 PLAZA MODELO NEW OSLO.
 ESTRUCTURA EN ALUMINIO COLOR BLANCO.
 COJIN DE TUMBONA DE 8CM DE GROSOR EN COLORES BLANCO Y GRIS CLARO
 CON RUEDA OCULTA DE TRANSPORTE..

Aa(cm)	sh(in)	Ar(cm)	Bh(in)	Ab(cm)	Aa(in)	PN(kg)	NW(lb)
38,0	15,0	30/80	11,8/31,5			18,8	41,4
						Ptos (pt)	
						652	

Aluminio	Textil	Ref.(code) 30200282
 Blanco SVAL1	 Blanco SVTL4	

Aluminio	Textil	Ref.(code) 30200283
 Blanco SVAL1	 Gris claro SVTL5	

DETALLES / DETAILS

163

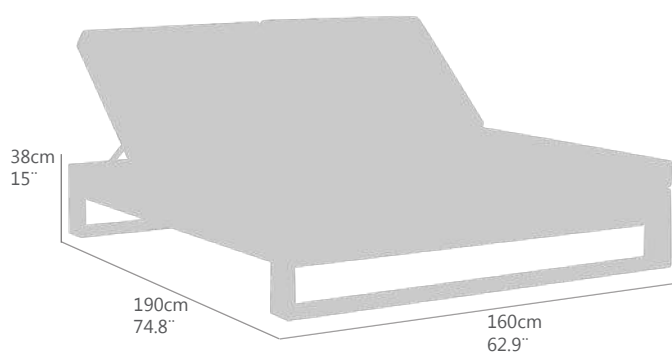

DAYBED 2 PLAZAS NEW OSLO

ESTRUCTURA EN ALUMINIO COLOR BLANCO

COJINERIA DE 10 CM DE GROSOR COLOR BLANCO O GRIS

RESPALDOS CON REGULACIÓN INDEPENDIENTE

Aa(cm)	sh(in)	Ar(cm)	Bh(in)	Ab(cm)	Aa(in)	PN(kg)	NW(lb)
40,0	15,7	30/80	11,8/31,5			31,5	69,4
						Ptos (pt)	
							1298



Ref.(code)
30200284



Ref.(code)
30200285

DETALLES / DETAILS
163

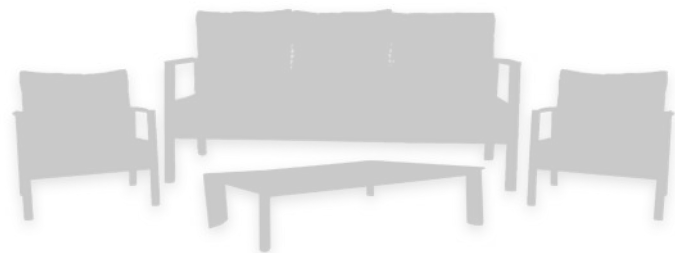

SET DE SOFÁ MODELO FOX

ESTRUCTURA EN ALUMINIO COLOR ANTRACITA CON BRAZOS EN TECA
COJIN DE ASIENTO (10 CM) Y RESPALDO (10 CM).

TEXTIL OLIFINE JASPEADO

CUERDA FINA TRENZADA DE ALTA CALIDAD

MESA RECTANGULAR CON ESTRUCTURA DE ALUMINIO

ENCIMERA DE PIEDRA SINTERIZADA COLOR ANTRACITA

Ptos (pt)

3336

Aluminio



Antracita
SVAL4

Textil



South End
161

Cuerda



R6
ED19

Ref.(code)
30201050

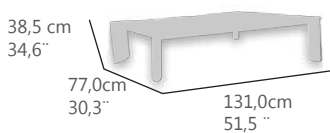
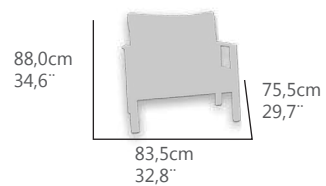
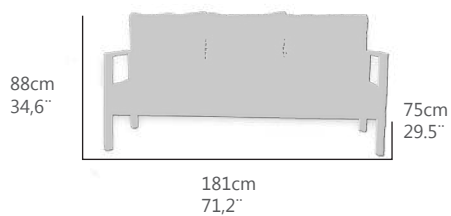

DETALLES / DETAILS

152

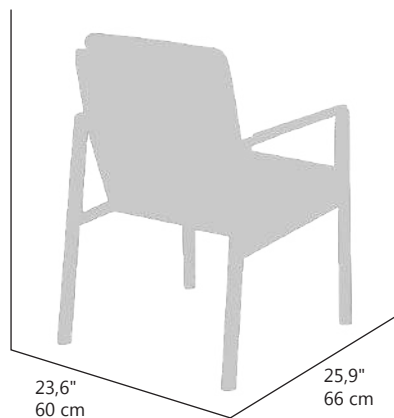

DETALLES / DETAILS
152

33,8"
86 cm23,6"
60 cm25,9"
66 cm

SILLA DE COMEDOR MODELO **FOX**
 ESTRUCTURA EN ALUMINIO COLOR ANTRACITA CON BRAZOS EN TEGA
 COJÍN DE ASIENTO (5 CM) Y RESPALDO (5 CM)
 TEXTIL OLIFINE JASPEADO
 CUERDA FINA TRENZADA DE ALTA CALIDAD
 NO APILABLE

Ptos (pt)
378

Aluminio

Textil

Antracita
SVAL4Gris Tempo
SVTX9

Ref.(code)
30201014

DETALLES / DETAILS

152

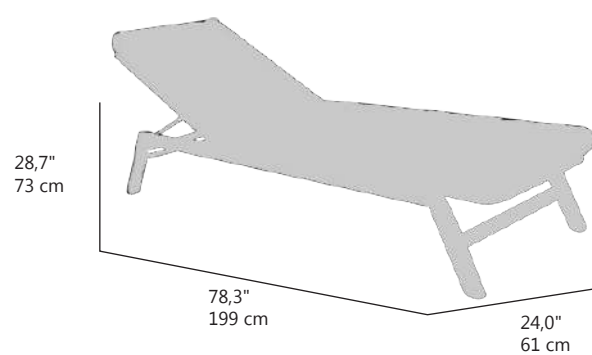

TUMBONA MODELO FOX
 ESTRUCTURA DE ALUMINIO COLOR ANTRACITA CON BRAZOS EN TEGA
 COJÍN DE ASIENTO (8 cm) Y RESPALDO (8 cm)
 TEXTIL OLIFINE JASPEADO
 CUERDA FINA TRENZADA DE ALTA CALIDAD.
 NO APILABLE.
 ALTA RESISTENCIA A LA INTEMPERIE.

Ptos (pt)
814

SIN BRAZOS

Aluminio

Textil



Antracita
SVAL4

Gris Tempo
SVTX9

Ref.(code)
30201059

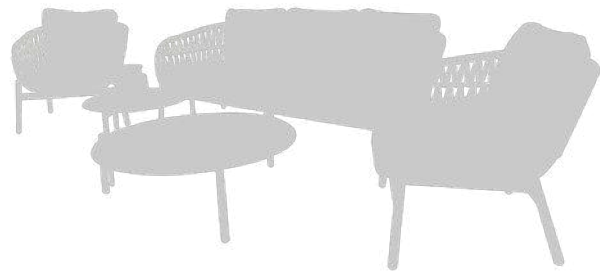
SET DE SOFÁ MODELO **BALI CLASSIC**

ESTRUCTURA EN ALUMINIO COLOR ANTRACITA Y COJIN DE ASIENTO (12 CM.) Y RESPALDO (12 CM.)

TEXTIL OLIFINE JASPEADO

CUERDA PLANA TRENZADA DE ALTA CALIDAD

MESAS REDONDAS AUXILIARES ALUMINIO COLOR ANTRACITA

Ptos (pt)
3609

Aluminio

Antracita
SVAL4

Textil

Atlas Sand
601.809

Cuerda

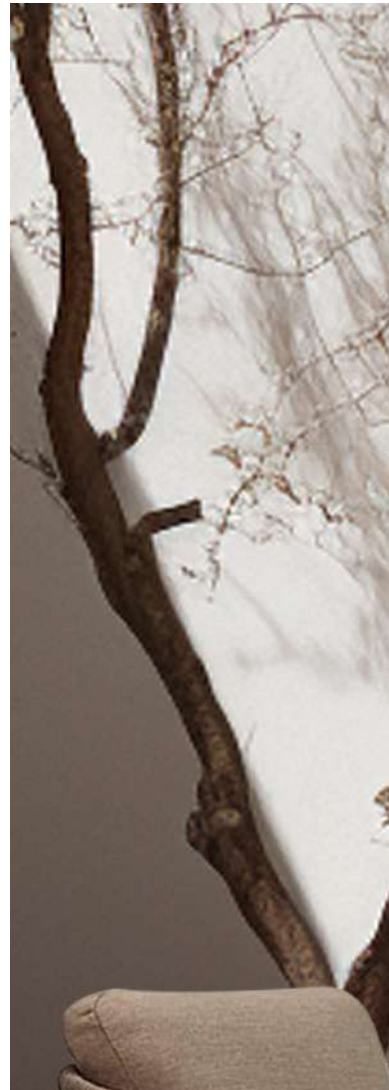
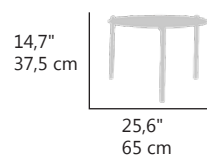
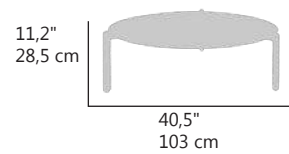
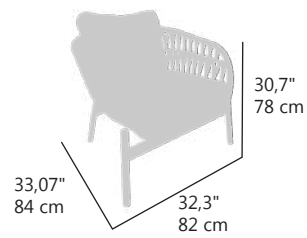
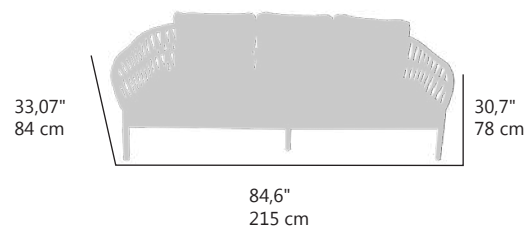
CHF
14-24Ref.(code)
30201030

DETALLES / DETAILS

153





SILLA DE COMEDOR MODELO **BALI CLASSIC**
 ESTRUCTURA DE ALUMINIO COLOR ANTRACITA
 COJÍN DE ASIENTO (5 CM) Y RESPALDO (5 CM)
 TEXTIL OLIFINE JASPEADO
 CUERDA PLANA TRENZADA DE ALTA CALIDAD
 NO APILABLE.

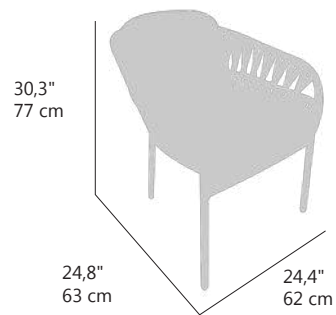

Ptos (pt)
345

Ref.(code)
30201035



28,9"
73,9 cm

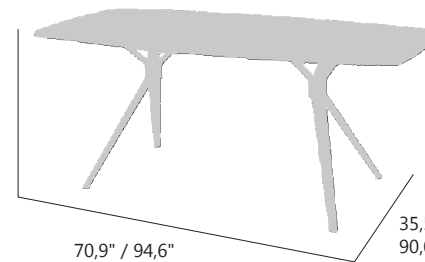

70,9" / 94,6"
180,0 / 240,0cm

35,5" / 39,4"
90,0 / 100,0 cm

MESA DE COMEDOR **BALI CLASSIC**

ESTRUCTURA EN ALUMINIO COLOR ANTRACITA

ENCIMERA ANTRACITA DE PIEDRA SINTERIZADA DE 12 MM

PATAS MACIZAS TIPO MARIPOSA

ALTA RESISTENCIA A LA INTEMPERIE

REQUIERE MONTAJE



180*90*73,9 cm

Ref.(code)
30201036

Ptos (pt)
1522

240*100*73,9 cm

Ref.(code)
30201027

Ptos (pt)
1950



DETALLES / DETAILS

153



MESA DE COMEDOR BALI CLASSIC
ESTRUCTURA EN ALUMINIO COLOR BLANCO
ENCIMERA BLANCA DE PIEDRA SINTERIZADA DE 12 MM
PATAS MACIZAS TIPO MARIPOSA
ALTA RESISTENCIA A LA INTEMPERIE
REQUIERE MONTAJE

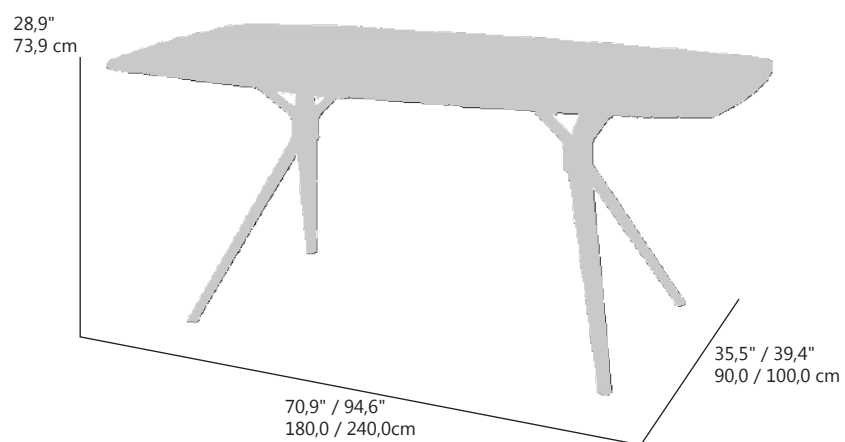

180*90*73,9 cm Ref.(code) **30201037**

Ptos (pt)
1522

240*100*73,9 cm Ref.(code) **30201026**

Ptos (pt)
1950



DETALLES / DETAILS
153

SET DE SOFA MODELO **TANGO**

ESTRUCTURA EN ALUMINIO COLOR BLANCO

COJÍN DE ASIENTO (10 cm) Y RESPALDO (10 cm)

TEXTIL OLIFINE JASPEADO

CUERDA REDONDA TRENZADA DE ALTA CALIDAD

MESA AUXILIAR RECTANGULAR CON ESTRUCTURA DE ALUMINIO BLANCO Y ENCIMERA DE PIEDRA SINTERIZADA REQUIERE MONTAJE

Ptos (pt)
3355



Ref.(code)
30201000

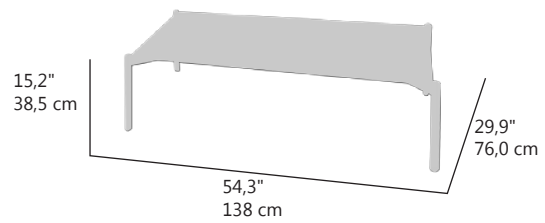
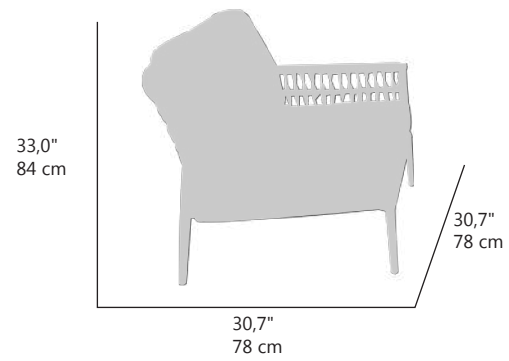
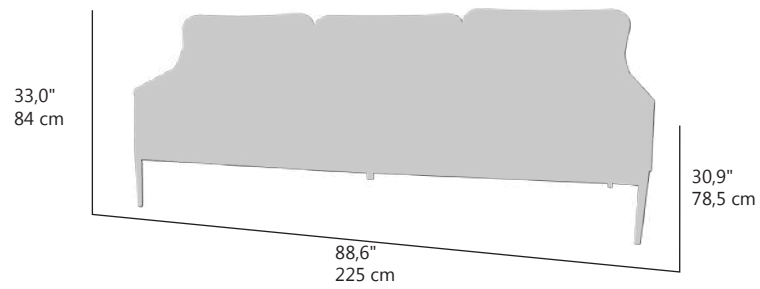
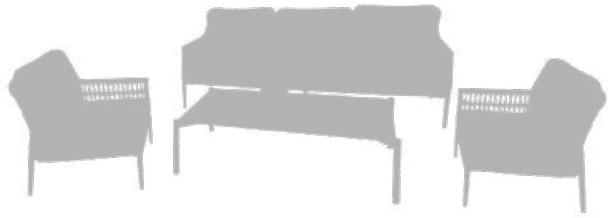

DETALLES / DETAILS
154-155



TUMBONA CON BRAZOS MODELO **TANGO**
 ESTRUCTURA DE ALUMINIO COLOR BLANCO Y COJIN DE 8CM
 TEXTIL OLIFINE JASPEADO
 CUERDA REDONDA TRENZADA DE ALTA CALIDAD
 NO APILABLE
 REQUIERE MONTAJE

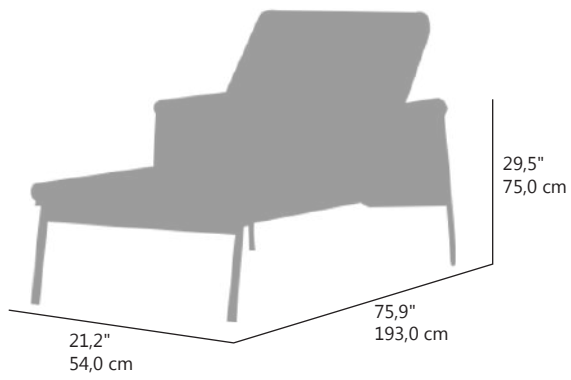

Ptos (pt)
736

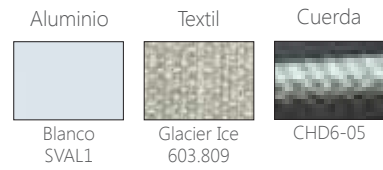

Ref.(code)
30201012



DETALLE DEL TRENZADO DE LA CUERDA

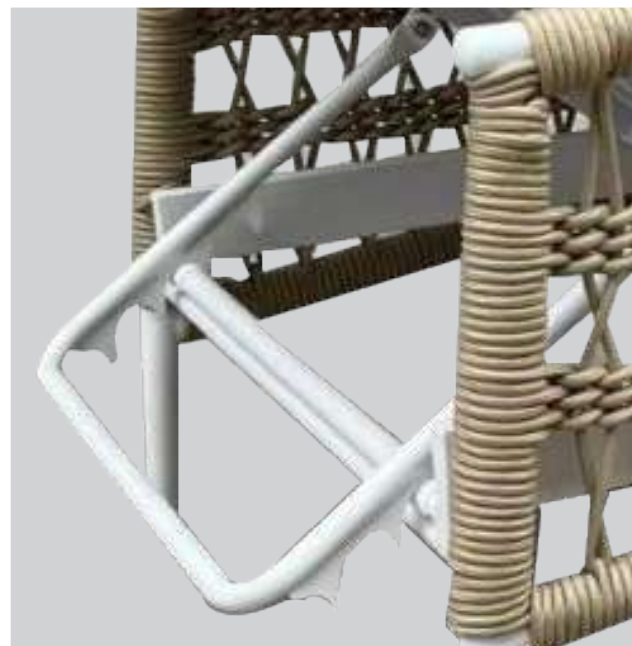

DETALLES / DETAILS
 154-155



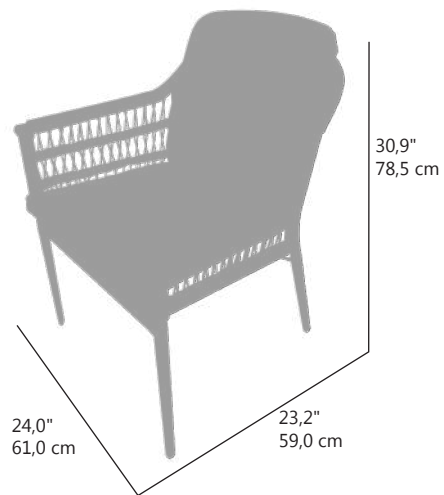

SILLA DE COMEDOR MODELO TANGO
 ESTRUCTURA DE ALUMINIO COLOR BLANCO
 COJÍN DE ASIENTO (5 CM) Y RESPALDO (5 CM)
 TEXTIL OLIFINE JASPEADO
 CUERDA REDONDA TRENZADA DE ALTA CALIDAD
 APILABLE.



Ref.(code)
30201005

Ptos (pt)
391

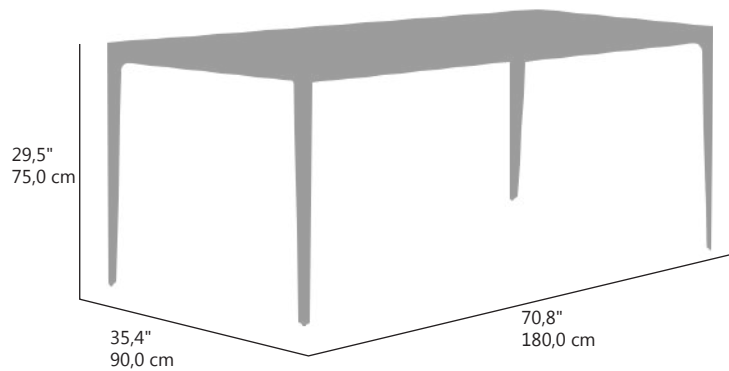

MESA DE COMEDOR MODELO TANGO RECTANGULAR
 ESTRUCTURA EN ALUMINIO COLOR BLANCO
 ENCIMERA BLANCA DE PIEDRA SINTERIZADA DE 12 MM
 ALTA RESISTENCIA A LA INTEMPERIE.
 REQUIERE MONTAJE.



180*90*75cm

Ref.(code)
30201006

Ptos (pt)
905

240*90*75cm

Ref.(code)
30201011

Ptos (pt)
1386



DETALLES / DETAILS
 154-155



MESA DE COMEDOR MODELO **TANGO** REDONDA
 ESTRUCTURA EN ALUMINIO COLOR BLANCO
 ENCIMERA BLANCA DE PIEDRA SINTERIZADA DE 12 MM
 ALTA RESISTENCIA A LA INTEMPERIE
 REQUIERE MONTAJE

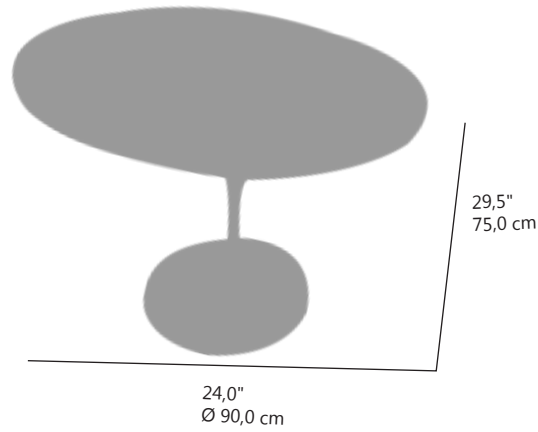

Ptos (pt)
657

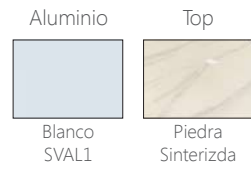

Ref.(code)
30201007

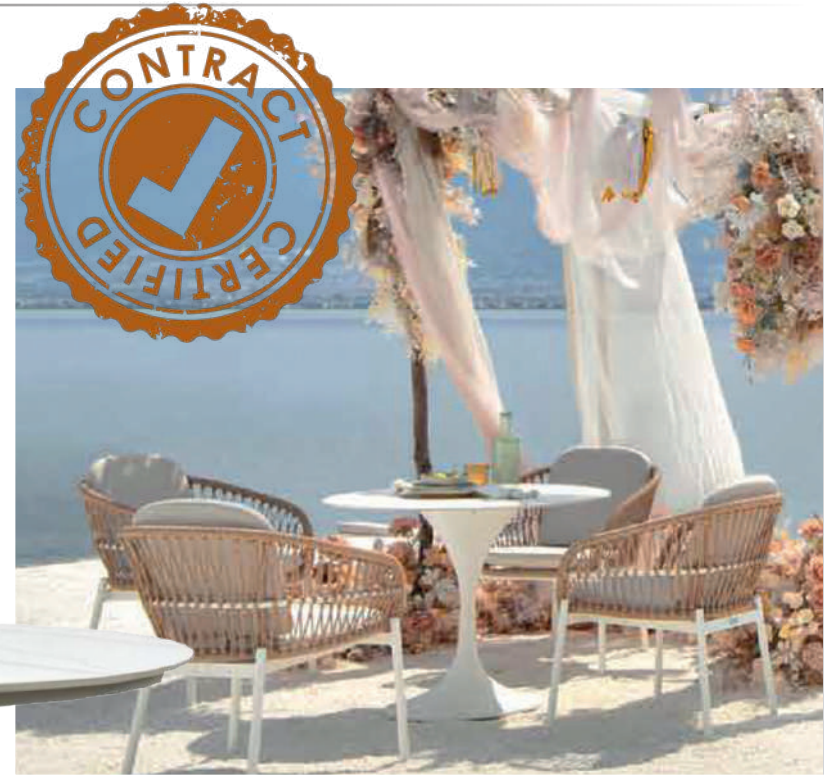

BALANCIN/SILLÓN RELAX
 ESTRUCTURA DE ALUMINIO COLOR BLANCO
 COJÍN DE ASIENTO (5 CM) Y RESPALDO (5 CM)
 TEXTIL OLIFINE JASPEADO
 CUERDA REDONDA TRENZADA DE ALTA CALIDAD
 NO APILABLE
 REQUIERE MONTAJE

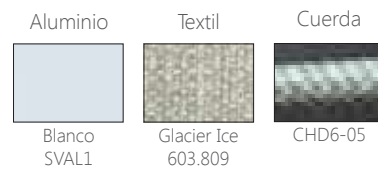
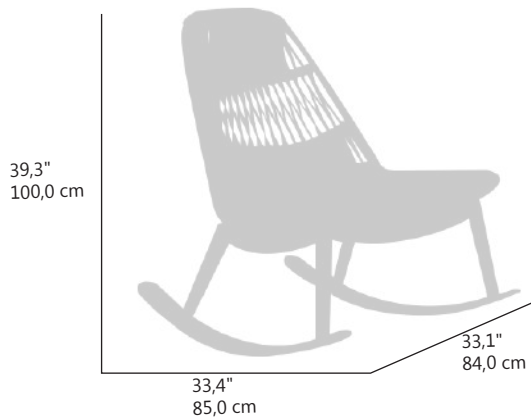

Ptos (pt)
708

Ref.(code)
30201010



DETALLES / DETAILS
154-155





SET DE SOFÁ MODELO **SOBER**

ESTRUCTURA EN ALUMINIO COLOR ANTRACITA

COJIN DE ASIENTO (12 CM) Y RESPALDO (12 CM)

TEXTIL OLIFINE JASPEADO

CUERDA REDONDA TRENZADA DE ALTA CALIDAD

MESA REDONDA AUXILIAR ALUMINIO COLOR ANTRACITA

Ptos (pt)
2982

Aluminio

Textil

Cuerda



Antracita
SVAL4



Copacobana
165



CHD6-34-35

Ref.(code)
30201040

DETALLE TEXTIL



32,3"
82,0 cm

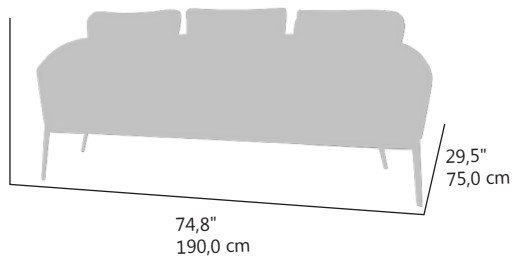

32,3"
82,0 cm

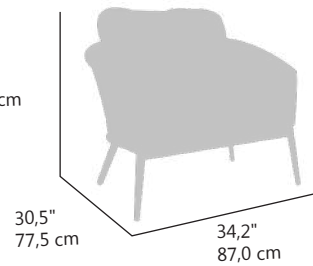

11,2"
28,5 cm

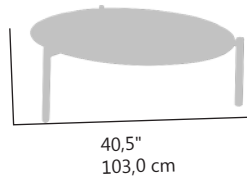

14,7"
37,5 cm



DETALLES / DETAILS

156-157



DETALLES / DETAILS
156-157

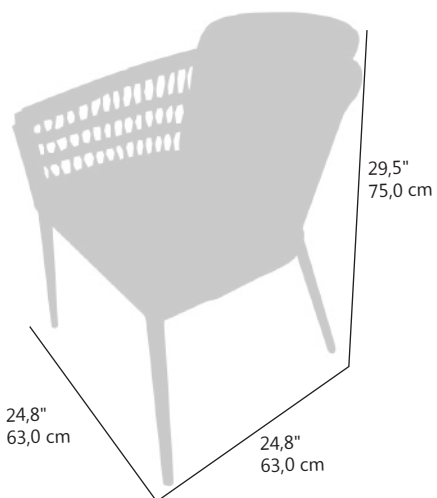

SILLA DE COMEDOR MODELO SOBER
 ESTRUCTURA DE ALUMINIO COLOR ANTRACITA
 COJÍN DE ASIENTO (5 cm) Y RESPALDO (5 cm)
 TEXTIL OLIFINE JASPEADO
 CUERDA REDONDA TRENZADA
 DE ALTA CALIDAD
 APILABLE



Ptos (pt)
395

Ref.(code)
30201045

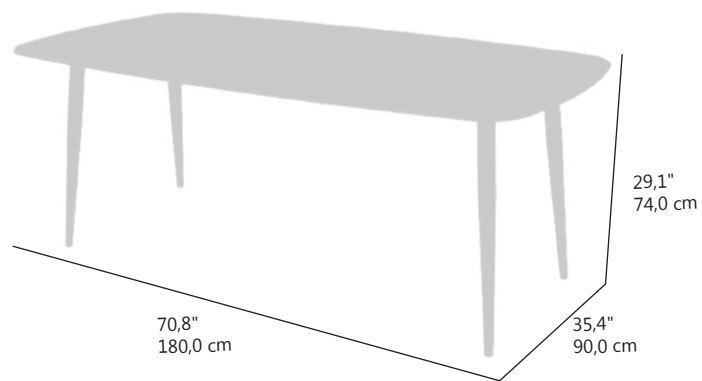

MESA DE COMEDOR SOBER
 ESTRUCTURA EN ALUMINIO COLOR ANTRACITA
 ENCIMERA ANTRACITA DE PIEDRA SINTERIZADA DE 12 MM
 ALTA RESISTENCIA A LA INTEMPERIE
 REQUIERE MONTAJE

Ptos (pt)
977



Ref.(code)
30201046



DETALLES / DETAILS
156-157



HADAR







SOFÁ DE 1 PLAZA MODELO HADAR

ESTRUCTURA EN ALUMINIO GREIGE O ANTRACITA Y CUERDA GRIS CLARO O ANTRACITA

REVESTIMIENTO EN TEXTIL GRIS CLARO O ANTRACITA

ALTA RESISTENCIA A LA INTEMPERIE.

Aa(cm)	sh(in)	Ab(cm)	Ah(in)	Ae(cm)	Fh(in)	PN(kg)	NW(lb)
43	16.9			77	30.3	18.7	41.2
						Ptos (pt)	
						842	

55cm
21.6"

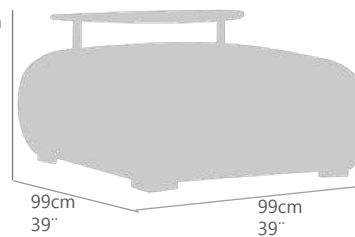

PUFF CON MESA AUXILIAR MODELO HADAR

ESTRUCTURA EN ALUMINIO GREIGE O ANTRACITA Y CUERDA GRIS CLARO O ANTRACITA

REVESTIMIENTO EN TEXTIL GRIS CLARO O ANTRACITA

ALTA RESISTENCIA A LA INTEMPERIE.

Aa(cm)	sh(in)	Ab(cm)	Ah(in)	Ae(cm)	Fh(in)	PN(kg)	NW(lb)
43	16.9			43		18.3	40.3
						Ptos (pt)	
						884	

80cm
31.5"

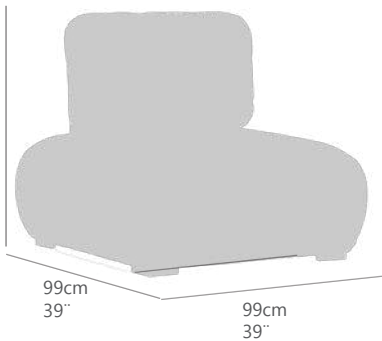

Estructura



Gris S,light
SVAL8

Textil

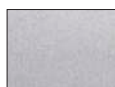

Gris claro
SVTL22

Ref.(code)
30200830

Estructura



Antracita
SVAL4

Textil

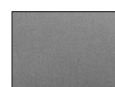

Gris flurotita
SVTL30

Ref.(code)
30200835

Estructura



Gris S,light
SVAL8

Textil



Gris claro
SVTL22

Ref.(code)
30200833

Estructura



Antracita
SVAL4

Textil



Gris flurotita
SVTL30

Ref.(code)
30200838

DETALLES / DETAILS

164-165

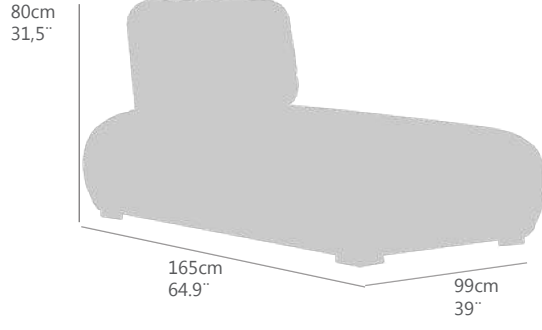
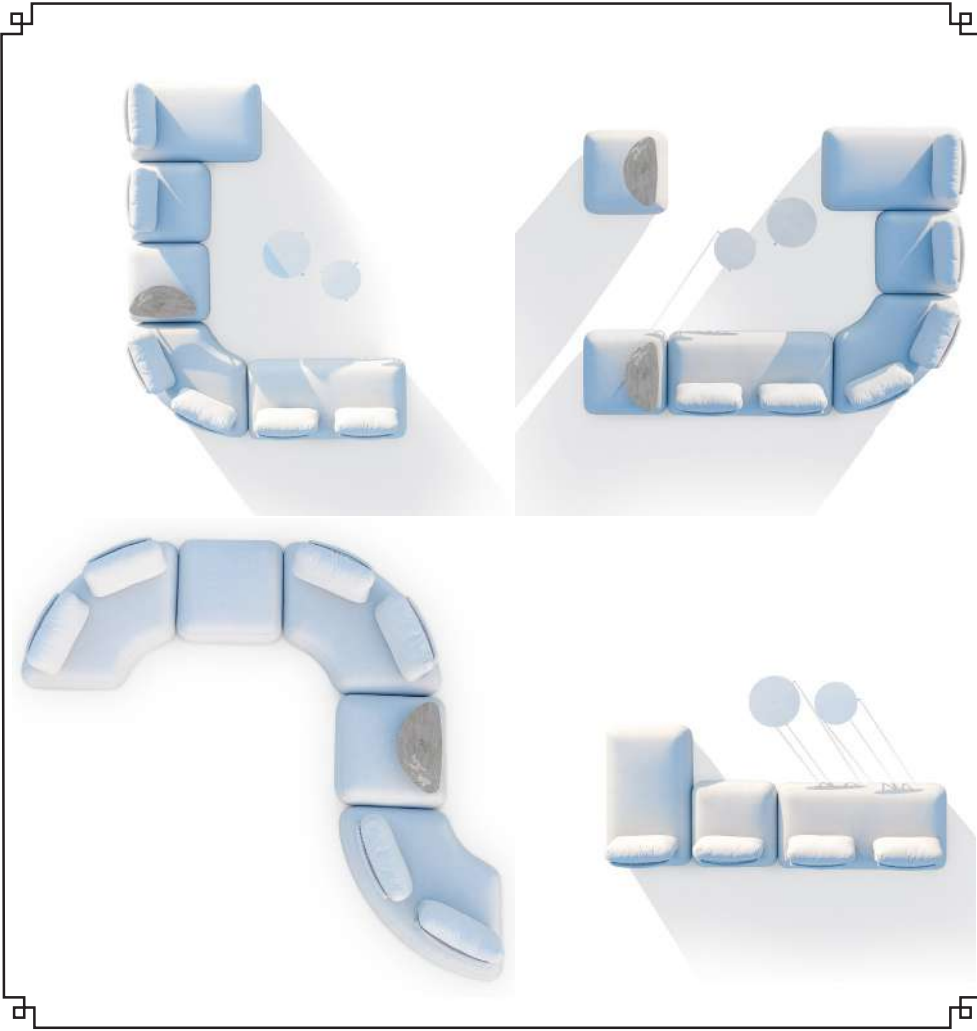

SOFÁ ESQUINERO MODELO HADAR

ESTRUCTURA EN ALUMINIO GREIGE O ANTRACITA Y CUERDA GRIS CLARO O ANTRACITA

REVESTIMIENTO EN TEXTIL GRIS CLARO O ANTRACITA

ALTA RESISTENCIA A LA INTEMPERIE.

Aa(cm)	sh(in)	Ab(cm)	Ah(in)	Ae(cm)	Fh(in)	PN(kg)	NW(lb)
43	16.9			77	30.3	31.8	70.1
Ptos (pt)							1520

Estructura	Textil	Ref.(code)
 Gris S,light SVAL8	 Gris claro SVTL22	30200831

Estructura	Textil	Ref.(code)
 Antracita SVAL4	 Gris flurotita SVTL30	30200836

TUMBONA LOUNGE MODELO HADAR.

ESTRUCTURA EN ALUMINIO GREIGE O ANTRACITA Y CUERDA GRIS CLARO O ANTRACITA

REVESTIMIENTO EN TEXTIL GRIS CLARO O ANTRACITA

ALTA RESISTENCIA A LA INTEMPERIE.

Aa(cm)	sh(in)	Ab(cm)	Ah(in)	Ae(cm)	Fh(in)	PN(kg)	NW(lb)
43	16.9			77	30.3	26.9	59.3
Ptos (pt)							1168

Estructura	Textil	Ref.(code)
 Gris S,light SVAL8	 Gris claro SVTL22	30200832

Estructura	Textil	Ref.(code)
 Antracita SVAL4	 Gris flurotita SVTL30	30200837

MESA AUXILIAR REDONDA

ESTRUCTURA DE ALUMINIO COLOR ANTRACITA O GRIS CLARO

TOP EN ALUMINIO LAMINADO 5MM GRIS

ALTA RESISTENCIA A LA INTEMPERIE.

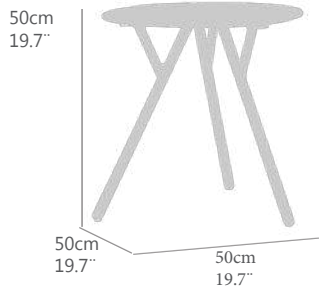

GT(cm)	TT(in)	Al(cm)	FH(in)	PN(kg)	NW(lb)
0,3	0,1	45,0	17,7	3,9	8,6
Ptos (pt)					220

Estructura	Ref.(code)
 Antracita SVAL4	30200840

Estructura	Ref.(code)
 Gris S,light SVAL8	30200633

MESA AUXILIAR REDONDA

ESTRUCTURA DE ALUMINIO COLOR ANTRACITA O GRIS CLARO

TOP EN ALUMINIO LAMINADO 5MM GRIS

ALTA RESISTENCIA A LA INTEMPERIE.

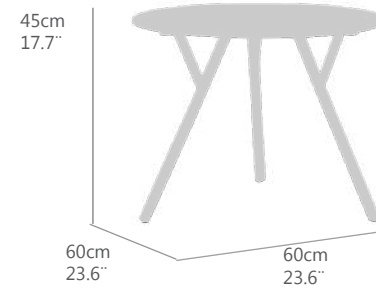

GT(cm)	TT(in)	Al(cm)	FH(in)	PN(kg)	NW(lb)
0,3	0,1	40,0	15,7	5,0	11,0
Ptos (pt)					264

Estructura	Ref.(code)
 Antracita SVAL4	30200841

Estructura	Ref.(code)
 Gris S,light SVAL8	30200634

VIKEN

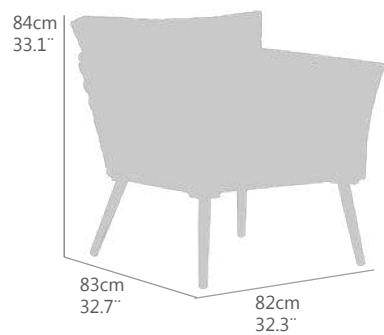

SOFA 1 PLAZA MODELO VIKEN

ESTRUCTURA DE ALUMINIO Y CUERDA ELASTICA EN OLEFINA DIFERENTES COLORES

COJIN DE ASIENTO Y RESPALDO (10 CM) COLOR GRIS CLARO.

Aa(cm)	sh(in)	Ar(cm)	Bh(in)	Ab(cm)	Aa(in)	PN(kg)	NW(lb)	
40,0	15,7	66,0	25,9	72	28,3	11,7	25,8	
Ptos (pt)							782	



Ref.(code)
30200670



Ref.(code)
30200674

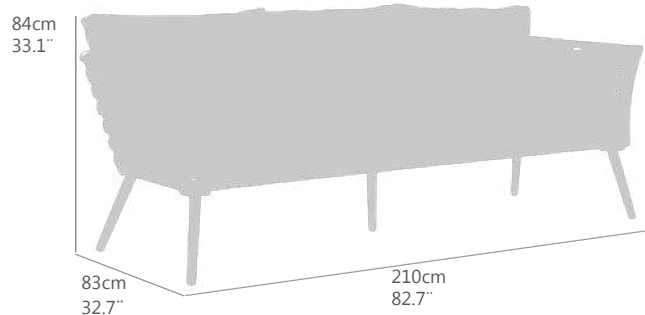

SOFA 3 PLAZAS MODELO VIKEN

ESTRUCTURA DE ALUMINIO Y CUERDA ELASTICA EN OLEFINA DIFERENTES COLORES

COJIN DE ASIENTO Y RESPALDO (10 CM) COLOR DIFERENTES COLORES

Aa(cm)	sh(in)	Ar(cm)	Bh(in)	Ab(cm)	Aa(in)	PN(kg)	NW(lb)	
40,0	15,7	66,0	25,9	72	28,3	29,5	65,0	
Ptos (pt)							1744	



Ref.(code)
30200671



Ref.(code)
30200675

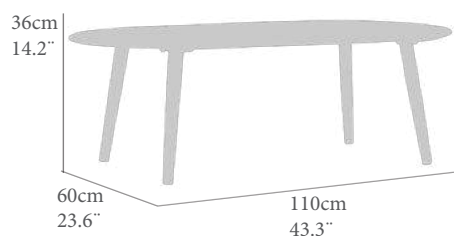

MESA AUXILIAR MODELO VIKEN

ESTRUCTURA DE ALUMINIO COLOR BLANCO

TOP DE ALUMINIO COLOR BLANCO

REQUIERE MONTAJE.

GT(cm)	TT(in)	Al(cm)	FH(in)	PN(kg)	NW(lb)
0,5	0,2	35,0	13,8	9,0	17,6
Ptos (pt)					372





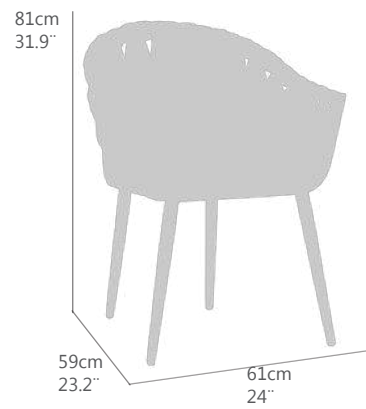



SILLA DE COMEDOR MODELO **VIKEN**

ESTRUCTURA DE ALUMINIO Y CUERDA ELASTICA EN OLEFINA EN DIVERSOS COLORES

COJIN DE ASIENTO DE 5CM CON COLORES A JUEGO

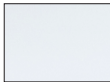
Aa(cm)	sh(in)	Ar(cm)	Bh(in)	Ab(cm)	Aa(in)	PN(kg)	NW(lb)	
47,0	18,5	64,5	25,4	81,0	31,9	5,7	12,5	
Ptos (pt)							306	

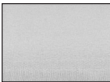
Aluminio	Cuerda	Textil	Ref.(code) 30200558
			
Blanco SVAL1	Gris claro SVCR1	Gris claro SVTL5	

Aluminio	Cuerda	Textil	Ref.(code) 30200560
			
Antracita SVAL4	Antracita SVCR3	Gris tiempo SVTX9	

MESA RECTANGULAR EXTENSIBLE MODELO **VIKEN**

ESTRUCTURA DE ALUMINIO COLOR BLANCO Y TOP EN LAMAS DE ALUMINIO COLOR BLANCO.

REQUIERE MONTAJE.

GT(cm)	TT(in)	Al(cm)	FH(in)	PN(kg)	NW(lb)
0,3	0,1	70,5	27,8		
Ptos (pt)					1138

Aluminio	Ref.(code) 30200414
	
Blanco SVAL1	

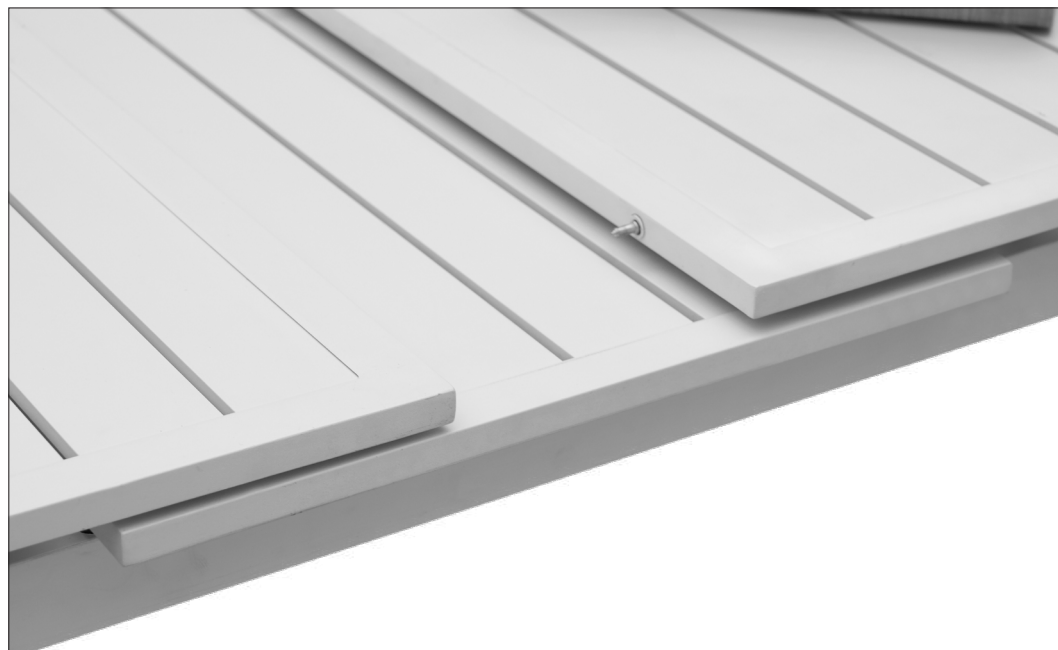
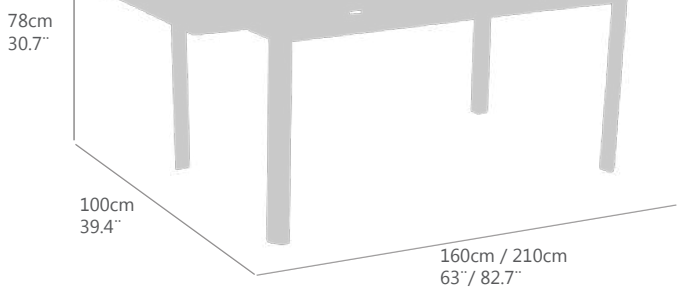

DETALLES / DETAILS

166-170



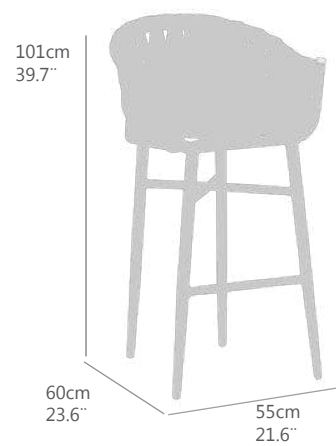

TABURETE ALTO MODELO VIKEN

ESTRUCTURA DE ALUMINIO Y CUERDA ELASTICA EN OLEFINA DE DIVERSOS COLORES

COJIN DE ASIENTO (5CM DE ESPESOR) DISTINTOS COLORES

Aa(cm)	sh(in)	Ab(cm)	Ah(in)	Ae(cm)	Fh(in)	PN(kg)	NW(lb)	
40,0	15,7	66,0	25,9	72	28,3	11,7	25,8	
Ptos (pt)								
							358	

Aluminio	Cuerda	Textil	
			Ref.(code) 30200660
Blanco SVAL1	Gris claro SVC1	Gris claro SVTL5	
Aluminio	Cuerda	Textil	
			Ref.(code) 30200661
Blanco SVAL1	laupé SVC2	laupé SVTL7	
Aluminio	Cuerda	Textil	
			Ref.(code) 30200662
Antracita SVAL4	Antracita SVC3	Gris tiempo SVTX9	

DETALLES / DETAILS
166-170

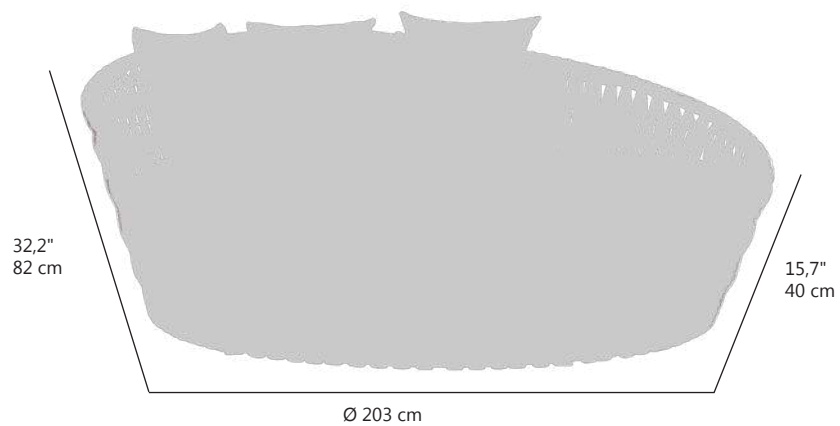

**DAYBED MODELO VIKEN**

ESTRUCTURA DE ALUMINIO Y CUERDA ELASTICA EN OLEFINA EN DIVERSOS COLORES

COLCHON DE 10 CM EN DISTINTOS COLORES

RESPALDO REGULABLE EN ALTURA

Aa(cm)	sh(in)	Ar(cm)	Bh(in)	Ae(cm)	Fh(in)	PN(kg)	NW(lb)
39,0	15,3	40/82	15,7/32,2	54	21,2	49	108
Ptos (pt)							
							2700

Aluminio

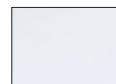
Blanco
SVAL1

Cuerda

Gris claro
SVCR1

Textil

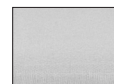
Gris claro
SVTL5

Ref.(code)

30200665

Aluminio

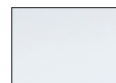
Blanco
SVAL1

Cuerda

Iaupe
SVCR2

Textil

Iaupe
SVTL7

Ref.(code)

30200666

Aluminio

Antracita
SVAL4

Cuerda

Antracita
SVCR3

Textil

Gris tempo
SVTX9

Ref.(code)

30200667

DETALLES / DETAILS

166-170



DETALLES / DETAILS
166-170

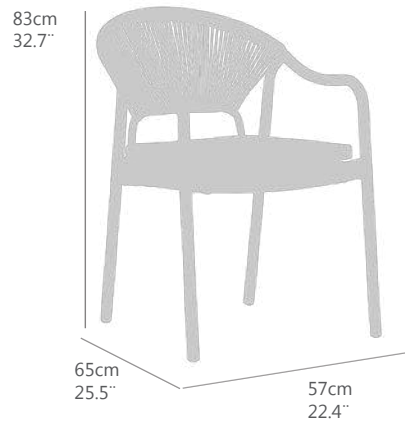





SILLA DE COMEDOR Vega

ESTRUCTURA DE ALUMINIO COLOR BLANCO O ANTRACITA Y CUERDA ELASTICA

EN OLEFINA COLOR GRIS CLARO O ANTRACITA

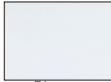
COJIN DE ASIENTO (5CM) COLOR GRIS CLARO O ANTRACITA.

Aa(cm)	sh(in)	Ab(cm)	Ah(in)	Ae(cm)	Fh(in)	PN(kg)	NW(lb)
44.5	17.5	67	26.3	83	32.7	4.4	9.7
Ptos (pt)							
							168

Aluminio	Cuerda	Textil	
			Ref.(code) 30200657
Blanco SVAL1	Gris claro SVC9	Gris medio SVTL27	
Aluminio	Cuerda	Textil	
			Ref.(code) 30200659
Antracita SVAL4	Antracita SVC7	Gris tiempo SVTX9	





DENEB



SOFA 1 PLAZA MODELO DENEb

ESTRUCTURA DE ALUMINIO COLOR ANTRACITA.

TRENZADO EN CUERDA SINTÉTICA 40x1.5MM COLOR ANTRACITA

COJINERIA ASIENTO 29CM (RESPALDO 12CM) COLOR GRIS MEDIO

ALTA RESISTENCIA A LA INTEMPERIE.

Aa(cm)	sh(in)	Ab(cm)	Ah(in)	Ae(cm)	Fh(in)	PN(kg)	NW(lb)
40,0	15,7	67,0	26,4	67,0	26,4	22,0	48,5
Ptos (pt)							1162

Aluminio

Cuerda

Textil



Antracita
SVAL4



Antracita
SVCR4



Gris medio
SVTL21

Ref.(code)
30200638

LATERAL BRAZO DERECHO MODELO DENEb

ESTRUCTURA DE ALUMINIO COLOR ANTRACITA

TRENZADO EN CUERDA SINTÉTICA 40x1.5 MM COLOR ANTRACITA

COJINERIA ASIENTO 29CM (RESPALDO 12 CM) COLOR GRIS MEDIO

ALTA RESISTENCIA A LA INTEMPERIE.

Aa(cm)	sh(in)	Ab(cm)	Ah(in)	Ae(cm)	Fh(in)	PN(kg)	NW(lb)
40,0	15,7	67,0	26,4	67,0	26,4	21,0	46,3
Ptos (pt)							1231

Aluminio

Cuerda

Textil



Antracita
SVAL4



Antracita
SVCR4



Gris medio
SVTL21

Ref.(code)
30200640

PUFF REPOSAPIES MODELO DENEb

ESTRUCTURA DE ALUMINIO COLOR ANTRACITA

TRENZADO EN CUERDA SINTÉTICA 40x1.5MM COLOR ANTRACITA

COJINERIA ASIENTO 29CM COLOR GRIS MEDIO

ALTA RESISTENCIA A LA INTEMPERIE.

Aa(cm)	sh(in)	Ab(cm)	Ah(in)	Ae(cm)	Fh(in)	PN(kg)	NW(lb)
40,0	15,7			40,0	15,7	11,5	25,4
Ptos (pt)							672

Aluminio

Cuerda

Textil



Antracita
SVAL4



Antracita
SVCR4



Gris medio
SVTL21

Ref.(code)
30200642

TUMBONA MODELO DENEb

ESTRUCTURA DE ALUMINIO COLOR ANTRACITA

TRENZADO EN CUERDA SINTÉTICA 40x1.5MM COLOR ANTRACITA

COJINERIA ASIENTO 29CM COLOR GRIS MEDIO

ALTA RESISTENCIA A LA INTEMPERIE.

Aa(cm)	sh(in)	Ab(cm)	Ah(in)	Ae(cm)	Fh(in)	PN(kg)	NW(lb)
40,0	15,7	40/102	15,7/40,1			31,0	68,3
Ptos (pt)							1448

Aluminio

Cuerda

Textil



Antracita
SVAL4



Antracita
SVCR4



Gris medio
SVTL21

Ref.(code)
30200643

MESA AUXILIAR MODELO DENEb

ESTRUCTURA DE ALUMINIO COLOR ANTRACITA

TRENZADO EN CUERDA SINTÉTICA 40x1.5MM COLOR ANTRACITA

TOP EN CRISTAL CERÁMICO 5MM GRIS

ALTA RESISTENCIA A LA INTEMPERIE.

GT(cm)	TT(in)	Al(cm)	FH(in)	PN(kg)	NW(lb)
0,5	0,2	38,0	15,0	22,5	49,6
Ptos (pt)					526

Aluminio

Cuerda

Cristal



Antracita
SVAL4



Antracita
SVCR4



Gris cerámico
SVCT11

Ref.(code)
30200637





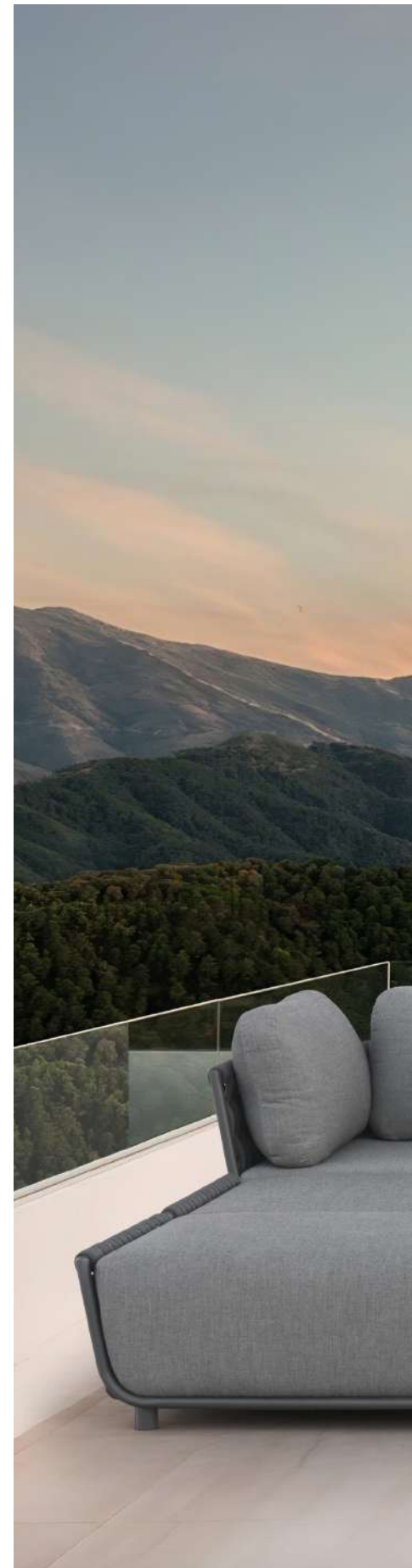

DETALLES / DETAILS
172-174

78

AA/SH: Alt. asiento (Seat height) **AB/AH:** Alt. Brazo (Arm height) **AR/BH:** Alt. respaldo (Arm height) **AE/FH:** Alt. estruct. (Frame height) **GT/TT:** Grosor top (Top Thickness) **AL/FH:** Altura libre (Free top height) **PN/NW:** Peso neto (Net weight)

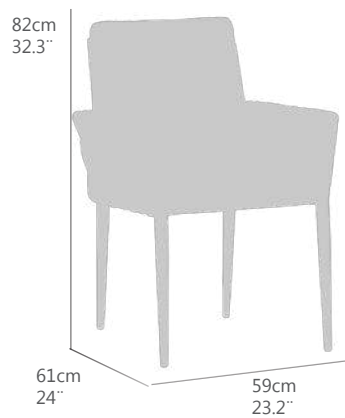

DETALLES / DETAILS
172-174

**SILLÓN DE COMEDOR DENEb**

ESTRUCTURA DE ALUMINIO COLOR ANTRACITA

TRENZADO EN CUERDA SINTÉTICA 40x1.5MM COLOR ANTRACITA

COJINERÍA ASIENTO Y RESPALDO 5CM COLOR GRIS MEDIO

ALTA RESISTENCIA A LA INTEMPERIE.

Aa(cm)	sh(in)	Ab(cm)	Ah(in)	Ae(cm)	Fh(in)	PN(kg)	NW(lb)	
42.0	16.5	61	24	80	31.5	6.4	14,1	
Ptos (pt)								
							400	

Aluminio

Antracita
SVAL4

Cuerda

Antracita
SVCR4

Textil

Gris medio
SVTL21Ref.(code)
30200651

DETALLES / DETAILS

172-174



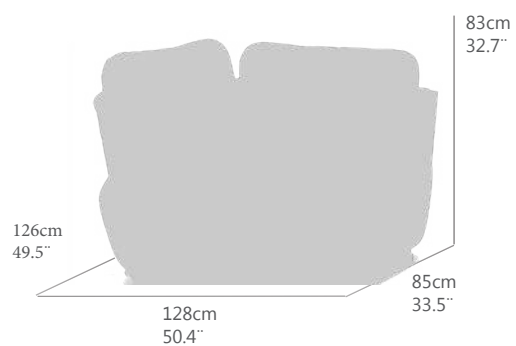

MODULO CURVO BRAZO DERECHO DENEb

ESTRUCTURA DE ALUMINIO COLOR ANTRACITA

TRENZADO EN CUERDA SINTÉTICA 40X15MM COLOR ANTRACITA

COJINERIA ASIENTO 29CM (RESPALDO 12CM) COLOR GRIS MEDIO

ALTA RESISTENCIA A LA INTEMPERIE

Aa(cm)	sh(in)	Ab(cm)	Ah(in)	Ae(cm)	Fh(in)	PN(kg)	NW(lb)
40,0	15,7	67,0	26,4	67,0	26,4	26,5	58,4
						Ptos (pt)	
						1478	



Ref.(code)
30200646

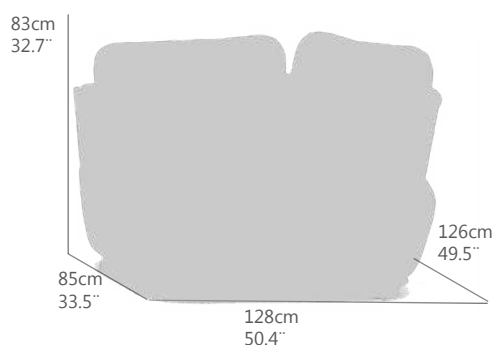

MODULO CURVO BRAZO IZQUIERDO DENEb

ESTRUCTURA DE ALUMINIO COLOR ANTRACITA

TRENZADO EN CUERDA SINTÉTICA 40X15MM COLOR ANTRACITA

COJINERIA ASIENTO 29CM (RESPALDO 12CM) COLOR GRIS MEDIO

ALTA RESISTENCIA A LA INTEMPERIE.

Aa(cm)	sh(in)	Ab(cm)	Ah(in)	Ae(cm)	Fh(in)	PN(kg)	NW(lb)
40,0	15,7	67,0	26,4	67,0	26,4	26,5	58,4
						Ptos (pt)	
						1478	



Ref.(code)
30200645



MODULO CURVO DENEb

ESTRUCTURA DE ALUMINIO COLOR ANTRACITA

TRENZADO EN CUERDA SINTÉTICA 40X15MM COLOR ANTRACITA

COJINERIA ASIENTO 29CM (RESPALDO 12CM) COLOR GRIS MEDIO

ALTA RESISTENCIA A LA INTEMPERIE.

Aa(cm)	sh(in)	Ab(cm)	Ah(in)	Ae(cm)	Fh(in)	PN(kg)	NW(lb)
40,0	15,7	67,0	26,4	67,0	26,4	29,0	63,9
						Ptos (pt)	
						2732	



Ref.(code)
30200647

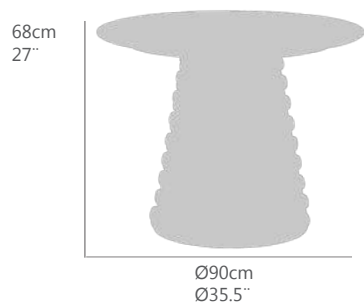

MESA REDONDA AUXILIAR DENEb

ESTRUCTURA DE ALUMINIO COLOR ANTRACITA

TRENZADO EN CUERDA SINTÉTICA 40X15MM COLOR ANTRACITA

TOP EN HPL 10MM GRIS

ALTA RESISTENCIA A LA INTEMPERIE.

GT(cm)	TT(in)	Al(cm)	FH(in)	PN(kg)	NW(lb)
1	0,4	65,0	25,6	17,1	37,7
				Ptos (pt)	
				944	



Ref.(code)
30200649

DETALLES / DETAILS
172-174





DETALLES / DETAILS
172-174

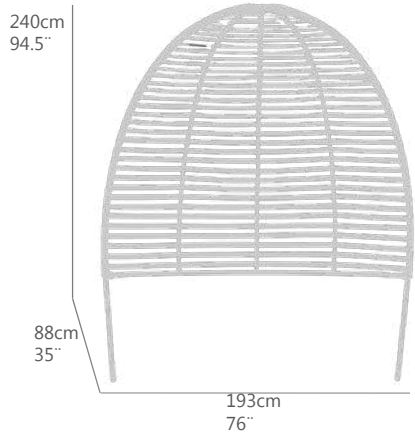
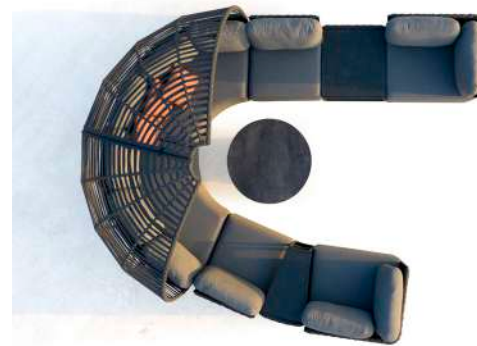

CUBIERTA SOLAR PARA MODULO CURVO DENE
ESTRUCTURA DE ALUMINIO COLOR ANTRACITA
TRENZADO EN CUERDA SINTÉTICA 40X15MM COLOR ANTRACITA
ALTA RESISTENCIA A LA INTEMPERIE.

GT(cm)	TT(in)	Al(cm)	FH(in)	PN(kg)	NW(lb)
				14,5	32
				Ptos (pt)	
				1102	



Ref.(code)
30200648

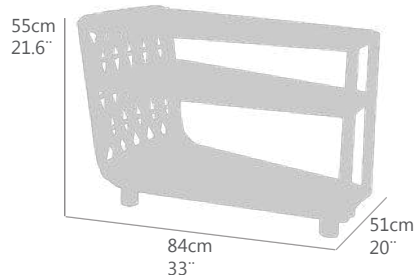

MESA AUXILIAR MODELO DENE
ESTRUCTURA DE ALUMINIO COLOR ANTRACITA
TRENZADO EN CUERDA SINTÉTICA 40X15MM COLOR ANTRACITA
TOP EN CRISTAL CERÁMICO 8MM GRIS
ALTA RESISTENCIA A LA INTEMPERIE.

GT(cm)	TT(in)	Al(cm)	FH(in)	PN(kg)	NW(lb)
0,8	0,3	50,0	19,7	17	21,4
				Ptos (pt)	
				668	



Ref.(code)
30200644

DETALLES / DETAILS
172-174



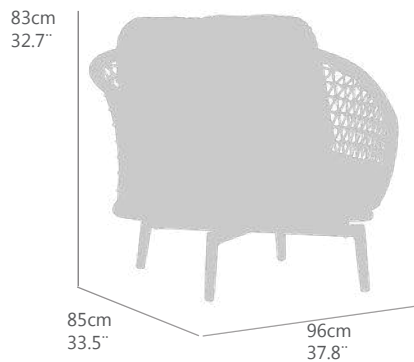

SOFA 1 PLAZA MODELO **BORGEN**
 ESTRUCTURA DE ALUMINIO COLOR **GRIS CLARO**
 TRENZADO EN CUERDA SINTÉTICA 6MM COLOR **GRIS CLARO**
 COJINERIA ASIENTO 15CM (RESPALDO 12CM) COLOR **GRIS CLARO**
 ALTA RESISTENCIA A LA INTEMPERIE.

Aa(cm)	sh(in)	Ab(cm)	Ah(in)	Ae(cm)	Fh(in)	PN(kg)	NW(lb)	
41,0	16,1	54,0	21,3	75,0	29,5	13,5	29,8	
Ptos (pt)							944	

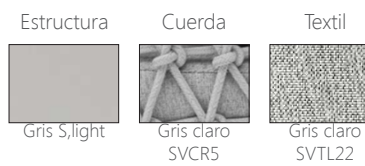

Ref.(code)
30200630

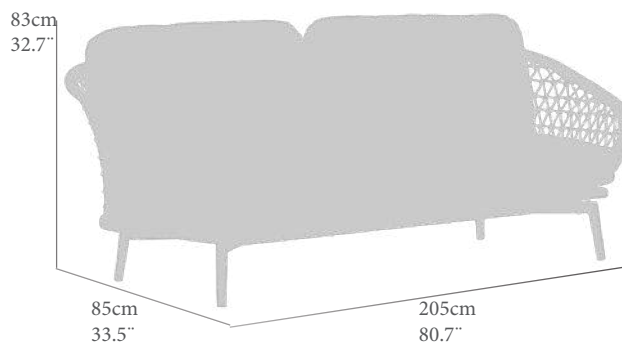

SOFA 2 PLAZAS MODELO **BORGEN**
 ESTRUCTURA DE ALUMINIO COLOR **GRIS CLARO**
 TRENZADO EN CUERDA SINTÉTICA 6MM COLOR **GRIS CLARO**
 COJINERIA ASIENTO 15CM (RESPALDO 12CM) COLOR **GRIS CLARO**
 ALTA RESISTENCIA A LA INTEMPERIE.

Aa(cm)	sh(in)	Ab(cm)	Ah(in)	Ae(cm)	Fh(in)	PN(kg)	NW(lb)	
41,0	16,1	54,0	21,3	75,0	29,5	29,0	63,9	
Ptos (pt)							1674	

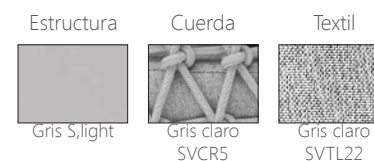

Ref.(code)
30200631

DETALLES / DETAILS

175

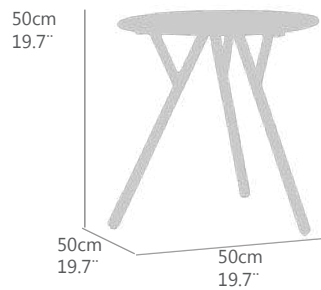

MESA AUXILIAR MODELO BORGEN
 ESTRUCTURA DE ALUMINIO COLOR GRIS CLARO
 TOP EN ALUMINIO LAMINADO 5MM GRIS
 ALTA RESISTENCIA A LA INTEMPERIE.

GT(cm)	TT(in)	Al(cm)	FH(in)	PN(kg)	NW(lb)
0,3	0,1	45,0	17,7	3,9	8,6
				Ptos (pt)	
				220	

Estructura

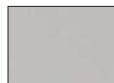

Ref.(code)
30200633

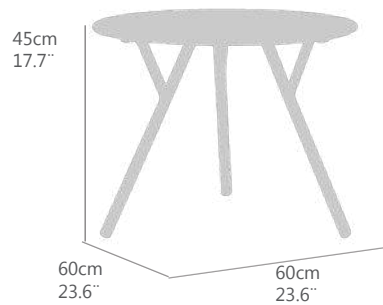

MESA AUXILIAR MODELO BORGEN
 ESTRUCTURA DE ALUMINIO COLOR GRIS CLARO
 TOP EN ALUMINIO LAMINADO 5MM GRIS
 ALTA RESISTENCIA A LA INTEMPERIE.

GT(cm)	TT(in)	Al(cm)	FH(in)	PN(kg)	NW(lb)
0,3	0,1	40,0	15,7	5,0	11,0
				Ptos (pt)	
				264	

Estructura

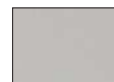

Ref.(code)
30200634

DETALLES / DETAILS
 175

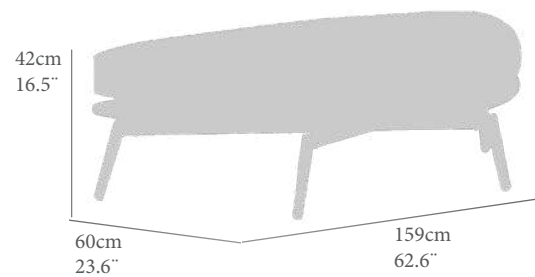
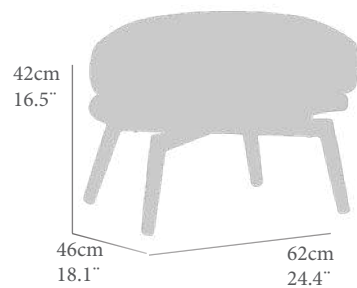

DETALLES / DETAILS
175

REPOSAPIES MODELO **BORGEN**

ESTRUCTURA DE ALUMINIO COLOR **GRIS CLARO**

TRENZADO EN CUERDA SINTÉTICA 6MM COLOR **GRIS CLARO**

COJINERIA ASIENTO 15CM (RESPALDO 12CM) COLOR **GRIS CLARO**

ALTA RESISTENCIA A LA INTEMPERIE.

Aa(cm)	sh(in)	Ab(cm)	Ah(in)	Ae(cm)	Fh(in)	PN(kg)	NW(lb)
41,0	16,1			26,0	10,2	4,1	9,0
						Ptos (pt)	
						300	

Estructura

Cuerda

Textil



Gris S,light
SVAL8



Gris claro
SVCR5



Gris claro
SVTL22

Ref.(code)
30200632

REPOSAPIES DOBLE MODELO **BORGEN**

ESTRUCTURA DE ALUMINIO COLOR **GRIS CLARO**

TRENZADO EN CUERDA SINTÉTICA 6MM COLOR **GRIS CLARO**

COJINERIA ASIENTO 15CM (RESPALDO 12CM) COLOR **GRIS CLARO**

ALTA RESISTENCIA A LA INTEMPERIE

Aa(cm)	sh(in)	Ab(cm)	Ah(in)	Ae(cm)	Fh(in)	PN(kg)	NW(lb)
41,0	16,1			26,0	10,2	10,0	22,0
						Ptos (pt)	
						300	

Estructura

Cuerda

Textil



Gris S,light
SVAL8



Gris claro
SVCR5



Gris claro
SVTL22

Ref.(code)
30200635

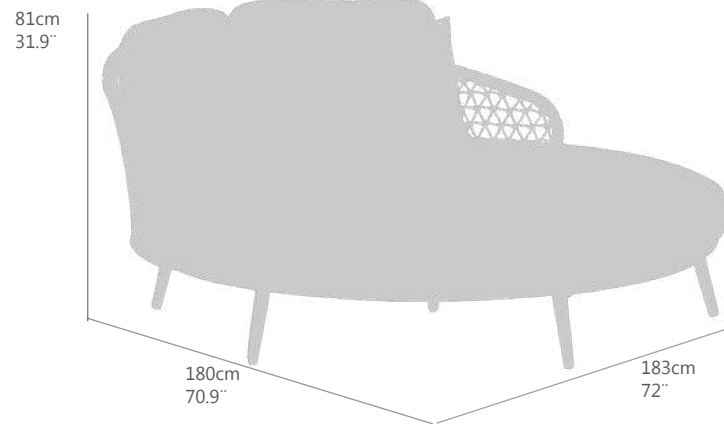

DAYBED MODELO BORGEN

ESTRUCTURA DE ALUMINIO COLOR GRIS CLARO

TRENZADO EN CUERDA SINTÉTICA 6MM COLOR GRIS CLARO

COJINERIA ASIENTO 15CM (RESPALDO 12CM) COLOR GRIS CLARO

ALTA RESISTENCIA A LA INTEMPERIE.

Aa(cm)	sh(in)	Ar(cm)	Bh(in)	Ae(cm)	Fh(in)	PN(kg)	NW(lb)
41,0	16,1	41/81	16,1/31,9	54,0	21,3	38,9	85,8
						Ptos (pt)	
						2234	

Estructura



Gris S,light
SVAL8

Cuerda



Gris claro
SVCR5

Textil



Gris claro
SVTL22

Ref.(code)
30200636

DETALLES / DETAILS

175



DETALLES / DETAILS
176-177

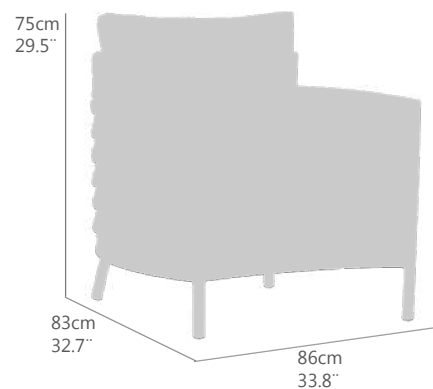

SOFÁ DE 1 PLAZA LONG ISLAND

ESTRUCTURA EN ALUMINIO COLOR GREIGE

COJÍN DE ASIENTO (10CM) Y RESPALDO (12CM) COLOR GRIS JASPEADO

REVESTIMIENTO EN CUERDA TRENZADA ALTA CALIDAD.

Aa(cm)	sh(in)	Ab(cm)	Ah(in)	Ae(cm)	Fh(in)	PN(kg)	NW(lb)	
40,0	15,7	62,0	24,4	70,0	27,6	15,2	33,5	
Ptos (pt)							1370	

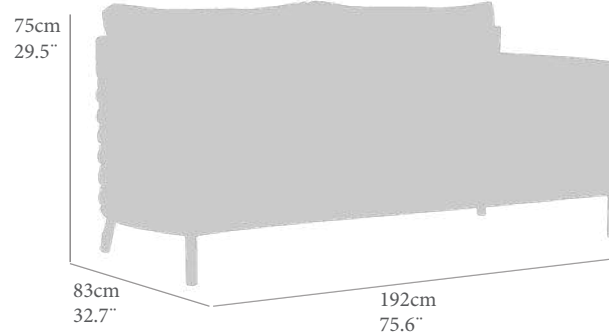
Ref.(code)
30200750

SOFÁ DE 2 PLAZAS MODELO LONG ISLAND

ESTRUCTURA EN ALUMINIO COLOR GREIGE

COJÍN DE ASIENTO (10CM) Y RESPALDO (12CM) COLOR GRIS JASPEADO

REVESTIMIENTO EN CUERDA TRENZADA ALTA CALIDAD.

Aa(cm)	sh(in)	Ab(cm)	Ah(in)	Ae(cm)	Fh(in)	PN(kg)	NW(lb)	
40,0	15,7	62,0	24,4	70,0	27,6	30,0	66,1	
Ptos (pt)							2728	

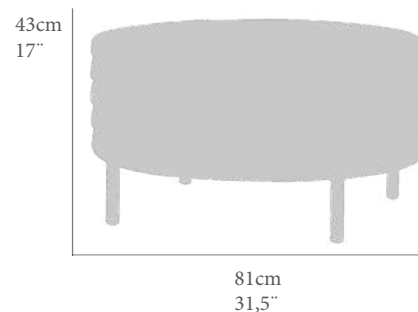
Ref.(code)
30200751

MESA AUXILIAR MODELO LONG ISLAND

ESTRUCTURA EN ALUMINIO COLOR GREIGE Y CRISTAL TEMPLADO DE 8MM TERMINACION OLD MARBLE

REVESTIMIENTO EN CUERDA TRENZADA DE ALTA CALIDAD.

GT(cm)	TT(in)	Al(cm)	FH(in)	PN(kg)	NW(lb)
0,8	0,3	13,0	5,11	16,5	21,0
Ptos (pt)					528

Ref.(code)
30200762DETALLES / DETAILS
176-177

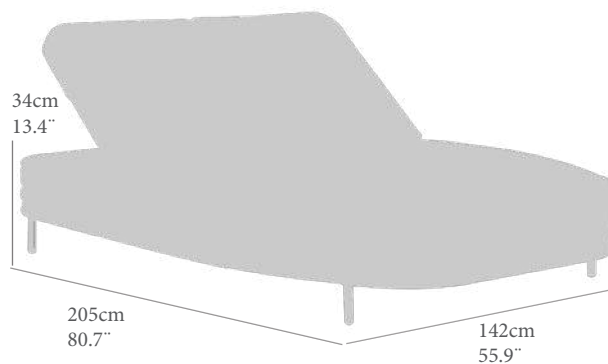
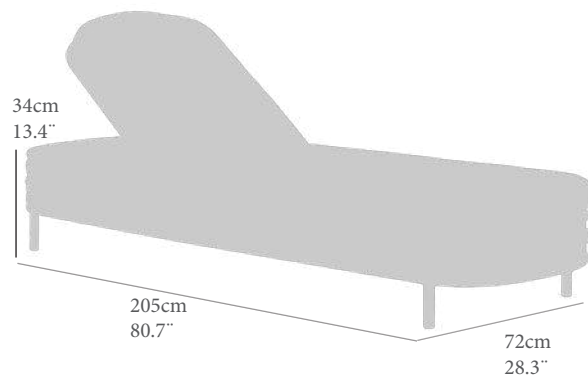

TUMBONA 1 PLAZA MODELO LONG ISLAND

ESTRUCTURA EN ALUMINIO COLOR GREIGE

COJÍN DE ASIENTO (10CM) Y RESPALDO (12CM) COLOR GRIS JASPEADO

REVESTIMIENTO EN CUERDA TRENZADA ALTA CALIDAD.

Aa(cm)	sh(in)	Ar(cm)	Bh(in)	Ae(cm)	Fh(in)	PN(kg)	NW(lb)
40,0	15,7	40/92	15,7/36,2			18,6	41,0
						Ptos (pt)	
						1520	

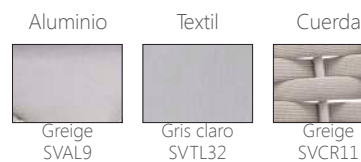

Ref.(code)
30200752

TUMBONA 2 PLAZAS MODELO LONG ISLAND

ESTRUCTURA EN ALUMINIO COLOR GREIGE

COJÍN DE ASIENTO (10CM) Y RESPALDO (12CM) COLOR GRIS JASPEADO

REVESTIMIENTO EN CUERDA TRENZADA ALTA CALIDAD.

Aa(cm)	sh(in)	Ar(cm)	Bh(in)	Ae(cm)	Fh(in)	PN(kg)	NW(lb)
40,0	15,7	40/92	15,7/36,2			35,5	78,3
						Ptos (pt)	
						1948	



Ref.(code)
30200753

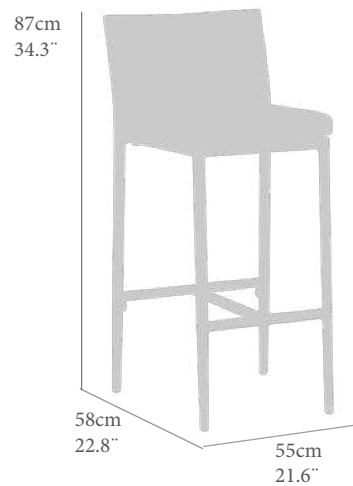

Taburete alto modelo **Long Island**
 Estructura en aluminio color **Greige**
 Cojinería acrílica (5cm) color **Gris Jaspeado**
 Revestimiento el cuerda trenzada de alta calidad.

Aa(cm)	sh(in)	Ab(cm)	Ah(in)	Ae(cm)	Fh(in)	PN(kg)	NW(lb)
73	28.7			103	40.5	4,9	11.0
						Ptos (pt)	
						440	

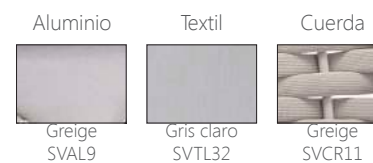

Ref.(code)
30200763

DETALLES / DETAILS
 176-177

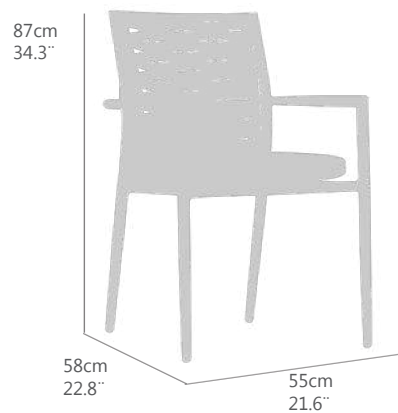

SILLÓN DE COMEDOR MODELO LONG ISLAND

ESTRUCTURA EN ALUMINIO COLOR GREIGE

COJINERIA ACRÍLICA (5cm) COLOR GRIS JASPEADO

REVESTIMIENTO EL CUERDA TRENZADA DE ALTA CALIDAD.

Aa(cm)	sh(in)	Ab(cm)	Ah(in)	Ae(cm)	Fh(in)	PN(kg)	NW(lb)	
47,0	18,5	65,0	25,6	87,0	34,3	4,6	10,1	
Ptos (pt)							328	



Ref.(code)
30200754

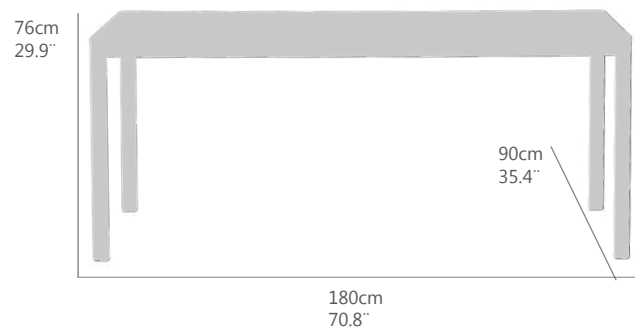

MESA DE COMEDOR MODELO LONG ISLAND

ESTRUCTURA EN ALUMINIO COLOR GREIGE

ENCIMERA EN CRISTAL TEMPLADO DE 8MM COLOR OLD MARBLE

GT(cm)	TT(in)	Al(cm)	FH(in)	PN(kg)	NW(lb)
0.8	0.3	89.0	35.0	23.7	52.2
Ptos (pt)					896



Ref.(code)
30200765

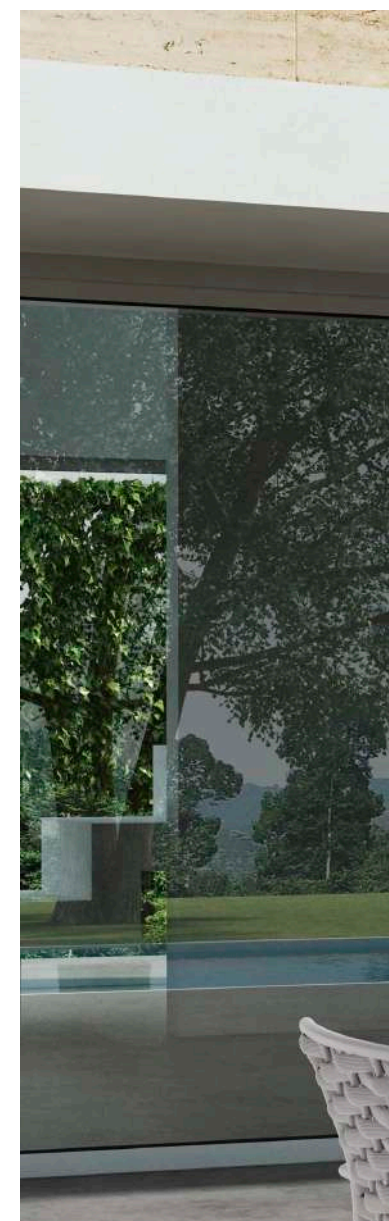

DETALLES / DETAILS

176-177







NIREA

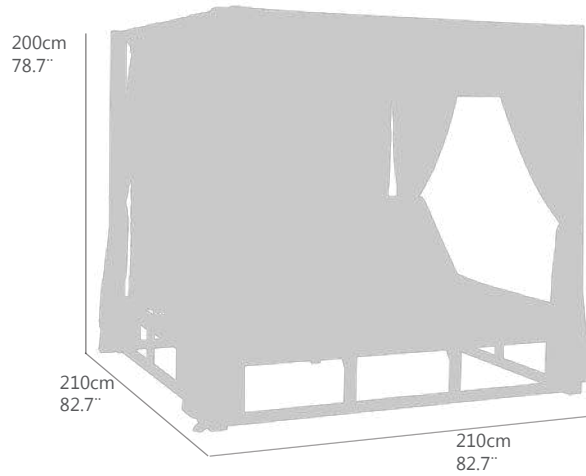

DAYBED NIREA

ESTRUCTURA EN **TECA** DE PRIMERA CALIDAD CON HERRAJES EN ACERO INOXIDABLE

COJINERIA **WATERPROOF (14cm)** COLOR **CRUDO**

CUBIERTA SUPERIOR Y CORTINAS INCLUIDAS

REQUIERE MONTAJE.

Aa(cm)	sh(in)	Ar(cm)	Bh(in)	Ae(cm)	Fh(in)	PN(kg)	NW(lb)
46,0	18,1	33/100	13-39,4			163,0	359,4
						Ptos (pt)	
						3832	



Ref.(code)
30100175



DETALLES / DETAILS
178





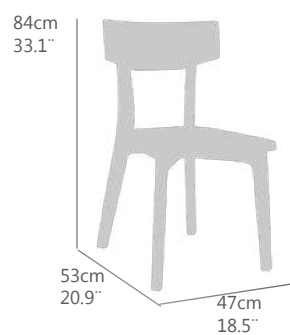

SILLA DE COMEDOR MODELO NIREA

TECA DE PRIMERA CALIDAD CON HERRAJES EN ACERO INOXIDABLE

REQUIERE MONTAJE.

Aa(cm)	sh(in)	Ab(cm)	Ah(in)	Ae(cm)	Fh(in)	PN(kg)	NW(lb)
45,0	17,7			84,0	33,1	9,5	20,9
Ptos (pt)							
							190

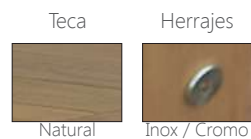

Ref.(code)
30100172

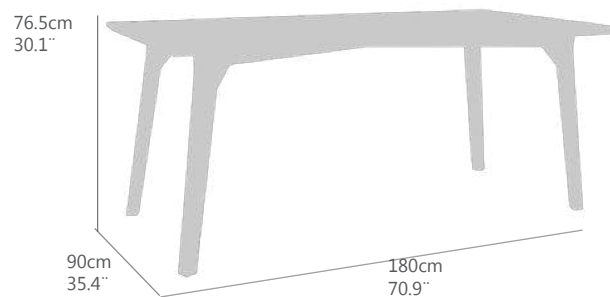

MESA DE COMEDOR RECTANGULAR NIREA

TECA DE PRIMERA CALIDAD CON HERRAJES EN ACERO INOXIDABLE

REQUIERE MONTAJE.

GT(cm)	TT(in)	Al(cm)	FH(in)	PN(kg)	NW(lb)
2,5	1,0	67,5	26,6	37,0	81,6
Ptos (pt)					
					506

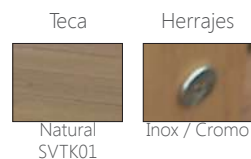

Ref.(code)
30100174

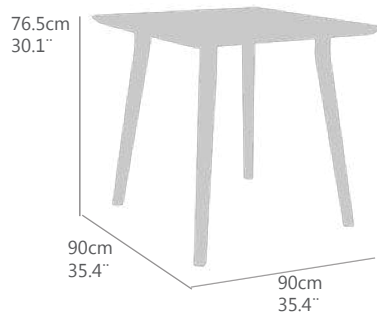

MESA DE COMEDOR CUADRADA NIREA

TECA DE PRIMERA CALIDAD CON HERRAJES EN ACERO INOXIDABLE.

REQUIERE MONTAJE.

GT(cm)	TT(in)	Al(cm)	FH(in)	PN(kg)	NW(lb)
2,5	1,0	67,5	26,6	19,0	41,9
Ptos (pt)					
					266

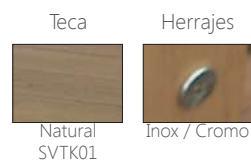

Ref.(code)
30100173



DETALLES / DETAILS
178





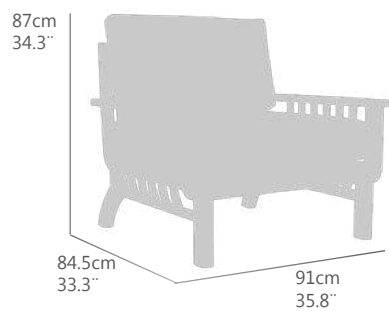

SOFA DE 1 PLAZA MODELO NIREA

TECA DE PRIMERA CALIDAD CON HERRAJES EN ACERO INOXIDABLE

COJINERIA DE ASIENTO (14CM) Y RESPALDO (12CM) COLOR BLANCO

REQUIERE MONTAJE.

Aa(cm)	sh(in)	Ab(cm)	Ah(in)	Ae(cm)	Fh(in)	PN(kg)	NW(lb)
44,0	17,3	54,5	21,5	76,5	30,1	25,5	56,2
						Ptos (pt)	
						606	



Ref.(code)
30100167

SOFA DE 2 PLAZAS MODELO NIREA

TECA DE PRIMERA CALIDAD CON HERRAJES EN ACERO INOXIDABLE

COJINERIA DE ASIENTO (14CM) Y RESPALDO (12CM) COLOR BLANCO

REQUIERE MONTAJE.

Aa(cm)	sh(in)	Ab(cm)	Ah(in)	Ae(cm)	Fh(in)	PN(kg)	NW(lb)
44,0	17,3	54,5	21,5	76,5	30,1	39,0	86,0
						Ptos (pt)	
						1346	



Ref.(code)
30100170

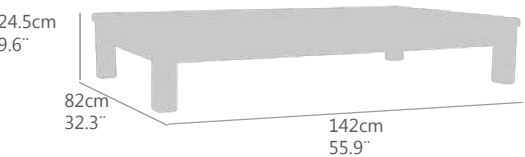
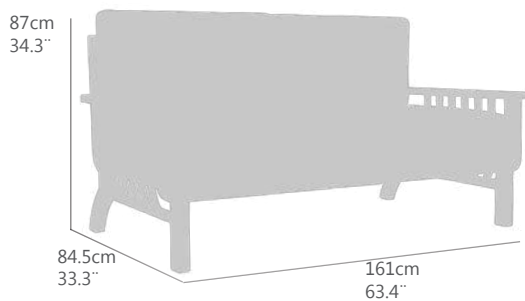

MESA AUXILIAR NIREA

TECA DE PRIMERA CALIDAD CON HERRAJES EN ACERO INOXIDABLE

REQUIERE MONTAJE.

GT(cm)	TT(in)	Al(cm)	FH(in)	PN(kg)	NW(lb)
2,5	1,0	14,5	5,7	27,0	59,5
				Ptos (pt)	
				458	

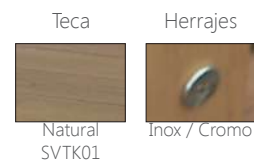

Ref.(code)
30100169

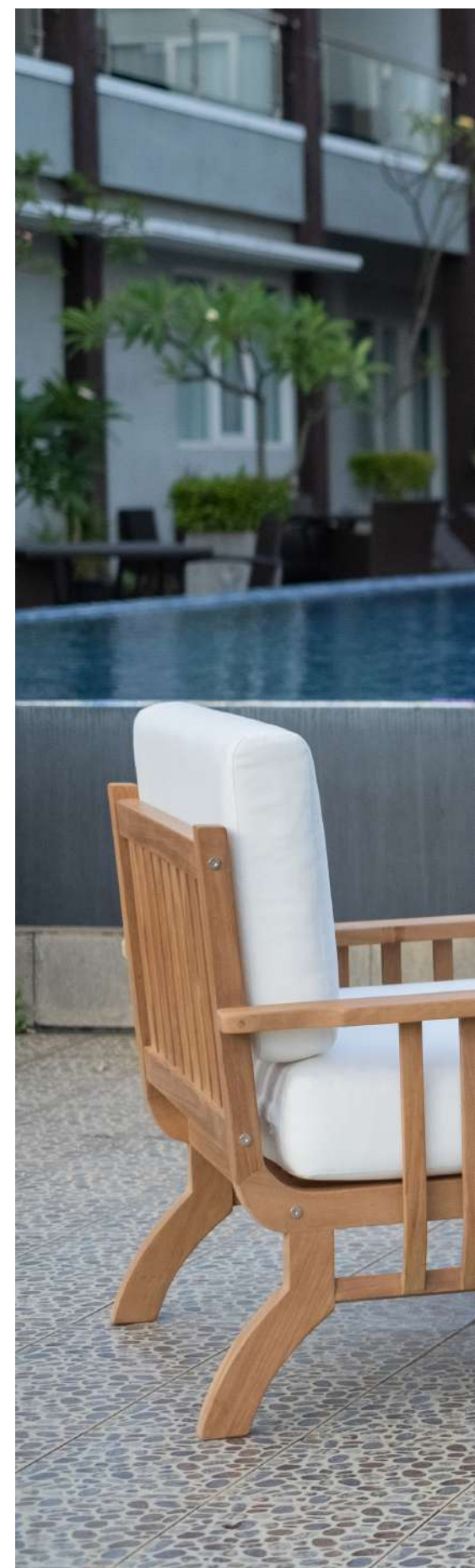



DETALLES / DETAILS
178

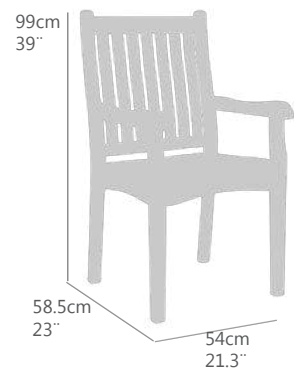

SILLA DE COMEDOR CON BRAZOS MODELO **JAVA**
 ESTRUCTURA EN **TECA** DE PRIMERA CALIDAD
 HERRAJES EN ACABADO INOXIDABLE
 REQUIERE MONTAJE.

Aa(cm)	sh(in)	Ab(cm)	Ah(in)	Ae(cm)	Fh(in)	PN(kg)	NW(lb)	
46,0	18,1	66,5	26,2	98,5	38,8	10,0	22,0	
Ptos (pt)							242	

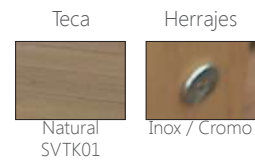

Ref.(code)
30100171

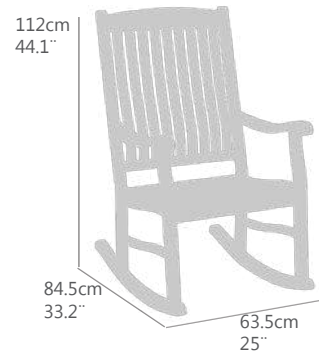

BUTACA MECEDORA MODELO **JAVA**
 ESTRUCTURA EN **TECA** DE PRIMERA CALIDAD
 HERRAJES EN ACABADO INOXIDABLE
 REQUIERE MONTAJE.

Aa(cm)	sh(in)	Ab(cm)	Ah(in)	Ae(cm)	Fh(in)	PN(kg)	NW(lb)	
47,0	18,5	73,0	28,7	112,0	44,1	17,0	37,5	
Ptos (pt)							248	

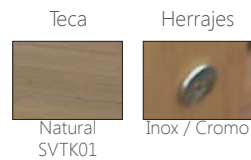

Ref.(code)
30100139





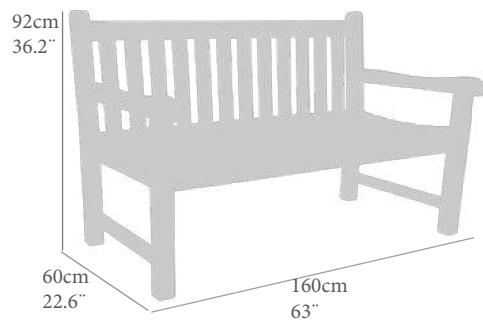

BUTACA 3 PLAZAS MODELO JAVA
 ESTRUCTURA EN **TECA** DE PRIMERA CALIDAD
 HERRAJES EN ACABADO INOXIDABLE
 REQUIERE MONTAJE.

Aa(cm)	sh(in)	Ab(cm)	Ah(in)	Ae(cm)	Fh(in)	PN(kg)	NW(lb)
45,0	17,7	67,5	26,6	92,0	36,2	26,0	57,3
Ptos (pt)							
							360zz



Ref.(code)
30100121

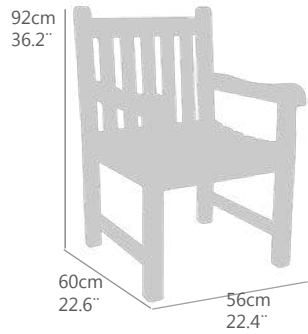

BUTACA 1 PLAZA MODELO JAVA
 ESTRUCTURA EN **TECA** DE PRIMERA CALIDAD
 HERRAJES EN ACABADO INOXIDABLE
 REQUIERE MONTAJE

Aa(cm)	sh(in)	Ab(cm)	Ah(in)	Ae(cm)	Fh(in)	PN(kg)	NW(lb)
45,0	17,7	67,5	26,6	92,0	36,2	13,0	28,7
Ptos (pt)							
							214z



Ref.(code)
30100093





DETALLES / DETAILS
179







TUMBONA PLEGABLE MODELO EDSON

ESTRUCTURA EN **TECA** DE PRIMERA CALIDAD Y **TEXTILENE BATYLINE** COLOR **NEGRO** O **BLANCO**

HERRAJES EN ACABADO INOXIDABLE

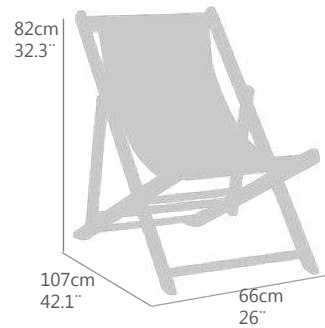

Aa(cm)	sh(in)	Ar(cm)	Bh(in)	Ae(cm)	Fh(in)	PN(kg)	NW(lb)
49,0	19,3	82,0	32,3			13,0	28,7
						Ptos (pt)	
						330	



Ref.(code)
30100154



Ref.(code)
30100164

DETALLES / DETAILS
180-181



112cm
44.1"**TABURETE ALTO MODELO EDSON**ESTRUCTURA EN **TECA** DE PRIMERA CALIDAD Y **TEXTILENE** BATYLINE COLOR **NEGRO**HERRAJES EN ACABADO **INOXIDABLE**

REQUIERE MONTAJE

Aa(cm)	sh(in)	Ab(cm)	Ah(in)	Ae(cm)	Fh(in)	PN(kg)	NW(lb)	
79,0	31,1	101,0	39,8	112,0	44,1	10,5	23,1	
Ptos (pt)								
392								

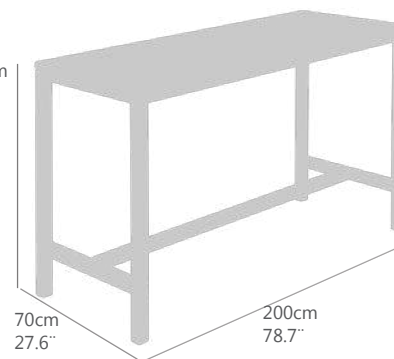
Ref.(code)
30100149Ref.(code)
30100163110cm
43.3"**MESA BAR ALTA MODELO EDSON**

TECA DE PRIMERA CALIDAD

HERRAJES EN ACERO INOXIDABLE

REQUIERE MONTAJE

GT(cm)	TT(in)	Al(cm)	FH(in)	PN(kg)	NW(lb)
2,5	1,0	102,0	40,2	28,0	61,7
Ptos (pt)					
920					

Ref.(code)
30100145DETALLES / DETAILS
180-181

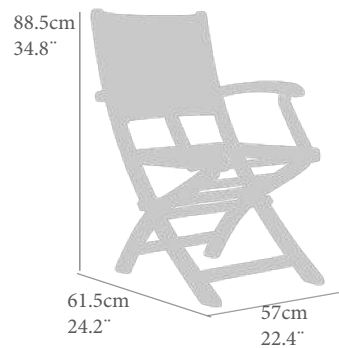

SILLA PLEGABLE MODELO EDSON

ESTRUCTURA EN **TECA** DE PRIMERA CALIDAD Y TEXTILENE **BATYLINE** COLOR **NEGRO** O **BLANCO**

HERRAJES EN ACABADO INOXIDABLE

Aa(cm)	sh(in)	Ab(cm)	Ah(in)	Ae(cm)	Fh(in)	PN(kg)	NW(lb)
44,0	17,3	65,0	25,6	88,0	34,6	8,0	17,6
Ptos (pt)							
							336

Teca	Textilene	Herrajes	
			Ref.(code) 30100146
Natural SVTK01	Negro SVTX6	Inox / Cromo	
Teca	Textilene	Herrajes	
			Ref.(code) 30100160
Natural SVTK01	Blanco SVTX7	Inox / Cromo	

MESA DE COMEDOR EXTENSIBLE MODELO VERNOM

TECA DE PRIMERA CALIDAD CON HERRAJES EN **ACERO INOXIDABLE**

GUIAS CORREDERAS EN **ACERO INOXIDABLE**

REQUIERE MONTAJE.

GT(cm)	TT(in)	Al(cm)	FH(in)	PN(kg)	NW(lb)
2,5	1,0	68	26,8	27,0	59,5
Ptos (pt)					
					1698

Teca	Extensión	Herrajes	
			Ref.(code) 30100136
Natural SVTK01	Guías metálicas	Inox / Cromo	

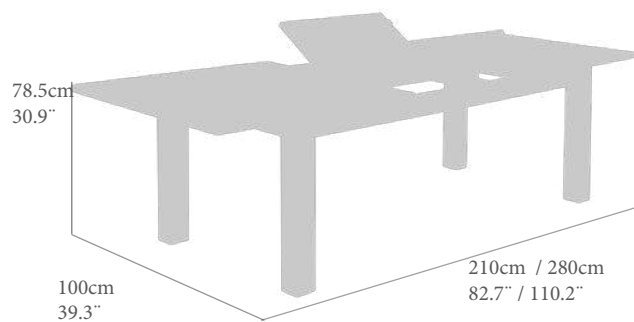

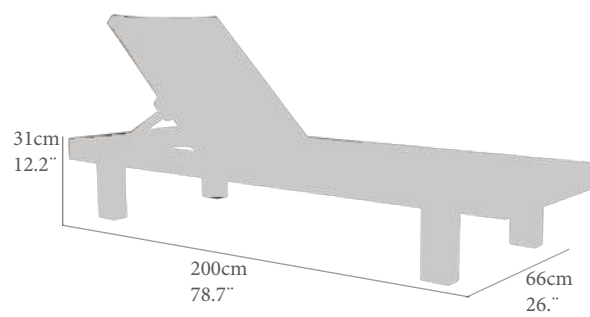

TUMBONA EDSON

ESTRUCTURA EN **TECA** DE PRIMERA CALIDAD Y **TEXTILENE BATYLINE** COLOR NEGRO O BLANCO

RESPALDO REGULABLE CON HERRAJES EN **ACERO INOXIDABLE**

REQUIERE MONTAJE.

Aa(cm)	sh(in)	Ar(cm)	Bh(in)	Ae(cm)	Fh(in)	PN(kg)	NW(lb)
31,0	12,2	31/91	12,2/35,8			27,5	60,6
						Ptos (pt)	
						680	

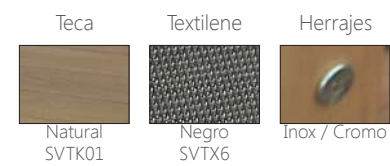

DETALLES / DETAILS
180-181



DETALLES / DETAILS
180-181

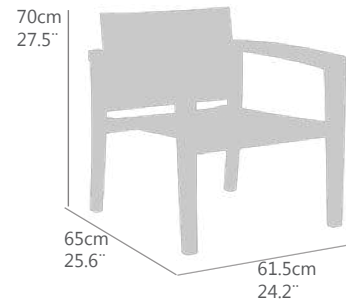

**SILLÓN RELAX MODELO EDSON**ESTRUCTURA EN **TECA** DE PRIMERA CALIDAD Y **TEXTILENE BATYLINE** COLOR **NEGRO** O **BLANCO****HERRAJES EN ACABADO INOXIDABLE**

REQUIERE MONTAJE.

Aa(cm)	sh(in)	Ab(cm)	Ah(in)	Ae(cm)	Fh(in)	PN(kg)	NW(lb)
35,0	13,8	58,0	22,8	69,0	27,2	9,0	19,8
Ptos (pt)							350

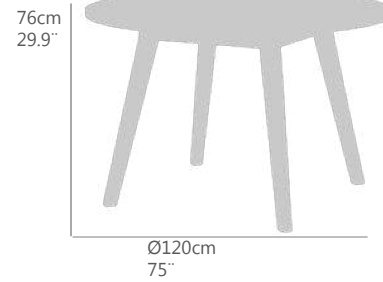
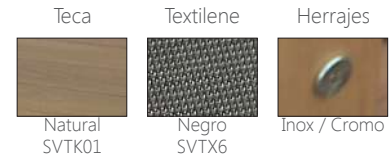
**MESA DE COMEDOR REDONDA MODELO EDSON****TECA DE PRIMERA CALIDAD CON HERRAJES EN ACERO INOXIDABLE**

REQUIERE MONTAJE.

GT(cm)	TT(in)	Al(cm)	FH(in)	PN(kg)	NW(lb)
2,5	1,0	68,0	26,8	19,0	41,9
Ptos (pt)					440



LOUNGE BRAZO DERECHO O IZQUIERDO MODELO VERNOM

TECA DE PRIMERA CALIDAD CON HERRAJES EN ACERO INOXIDABLE

COJINERIA DE ASIENTO(14CM) Y RESPALDO(17CM) COLOR CRUDO

REQUIERE MONTAJE.

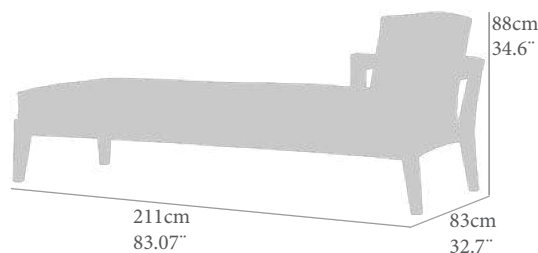

Aa(cm)	sh(in)	Ab(cm)	Ah(in)	Ae(cm)	Fh(in)	PN(kg)	NW(lb)
44,0	17,3	64,0	25,2	64,0	25,2	40,6	89,5
Ptos (pt)							
							1240



DERECHO

Ref.(code)

30100142



IZQUIERDO

Ref.(code)

30100141

TRAMO INTERMEDIO MODELO VERNOM

TECA DE PRIMERA CALIDAD CON HERRAJES EN ACERO INOXIDABLE

COJINERIA DE ASIENTO(14CM) Y RESPALDO(17CM) COLOR CRUDO

REQUIERE MONTAJE.

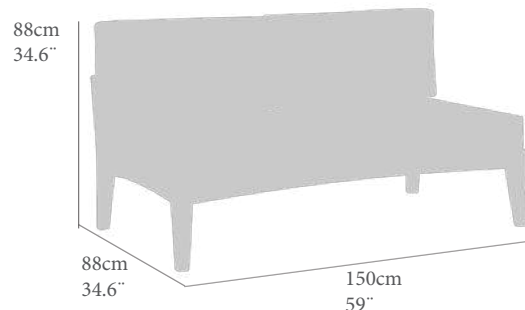

Aa(cm)	sh(in)	Ab(cm)	Ah(in)	Ae(cm)	Fh(in)	PN(kg)	NW(lb)
44,0	17,3			64,0	25,2	30,4	67,0
Ptos (pt)							
							1152



Ref.(code)

30100143

TRAMO DE AMPLIACIÓN MODELO VERNOM

TECA DE PRIMERA CALIDAD CON HERRAJES EN ACERO INOXIDABLE

COJINERIA DE ASIENTO(14CM) Y RESPALDO(17CM) COLOR CRUDO

REQUIERE MONTAJE.

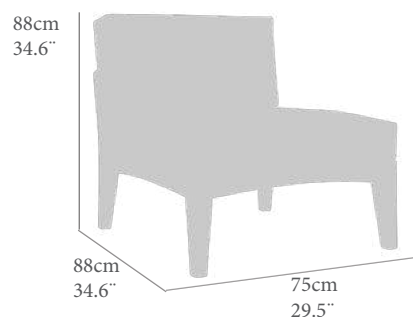

Aa(cm)	sh(in)	Ab(cm)	Ah(in)	Ae(cm)	Fh(in)	PN(kg)	NW(lb)
44,0	17,3			64,0	25,2	22,2	48,9
Ptos (pt)							
							600



Ref.(code)

30100210

MODULO DE ESQUINA MODELO VERNOM

TECA DE PRIMERA CALIDAD CON HERRAJES EN ACERO INOXIDABLE

COJINERIA DE ASIENTO(14CM) Y RESPALDO(17CM) COLOR CRUDO

REQUIERE MONTAJE.

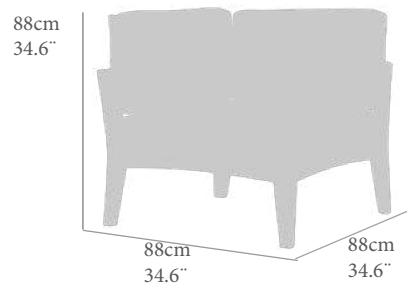

Aa(cm)	sh(in)	Ab(cm)	Ah(in)	Ae(cm)	Fh(in)	PN(kg)	NW(lb)
44,0	17,3	64,0	25,2	64,0	25,2	25,2	55,6
Ptos (pt)							
							846



Ref.(code)

30100144

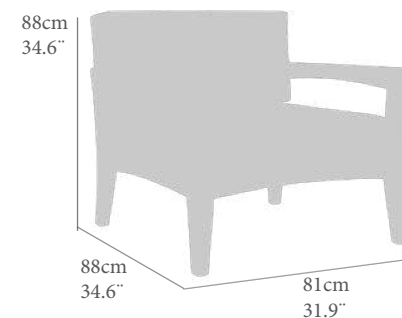

DETALLES / DETAILS

182-183





MODULO BRAZO IZQUIERDO O DERECHO MODELO VERNOM

TECA DE PRIMERA CALIDAD CON HERRAJES EN ACERO INOXIDABLE

COJINERIA DE ASIENTO(14CM) Y RESPALDO(17CM) COLOR CRUDO

REQUIERE MONTAJE.

Aa(cm)	sh(in)	Ab(cm)	Ah(in)	Ae(cm)	Fh(in)	PN(kg)	NW(lb)
44,0	17,3	64,0	25,2	64,0	25,2	23,2	51,1
Ptos (pt)							
							600

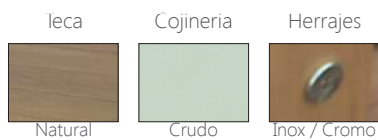

IZQUIERDO

Ref.(code)
30100211

DERECHO

Ref.(code)
30100212

MESA AUXILIAR MODELO VERNOM

TECA DE PRIMERA CALIDAD CON HERRAJES EN ACERO INOXIDABLE

COJINERIA DE ASIENTO(14CM) Y RESPALDO(17CM) COLOR CRUDO

REQUIERE MONTAJE.

GT(cm)	TT(in)	Al(cm)	FH(in)	PN(kg)	NW(lb)
2,5	1,0	24,0	9,4	10,0	22,0
Ptos (pt)					
					554

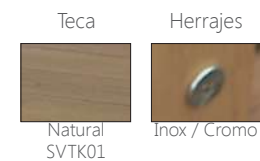
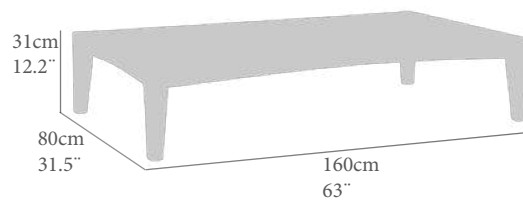

Ref.(code)
30100135

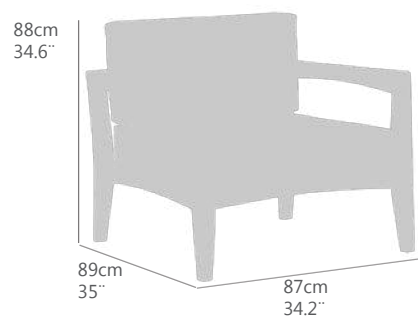

SOFÁ DE UNA PLAZA MODELO VERNOM
 TECA DE PRIMERA CALIDAD CON HERRAJES EN ACERO INOXIDABLE
 COJINERIA DE ASIENTO(14CM) Y RESPALDO(17CM) COLOR CRUDO
 REQUIERE MONTAJE

Aa(cm)	sh(in)	Ab(cm)	Ah(in)	Ae(cm)	Fh(in)	PN(kg)	NW(lb)
44,0	17,3	64,0	25,2	64,0	25,2	23,2	51,1
Ptos (pt)							620



Ref.(code)
30100132

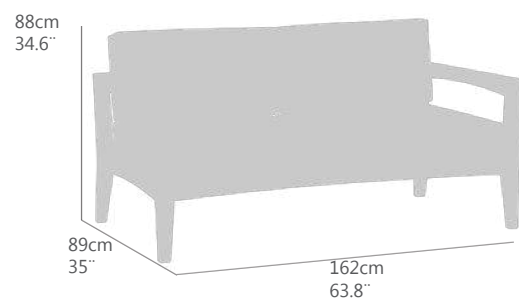

SOFÁ DE DOS PLAZAS MODELO VERNOM
 TECA DE PRIMERA CALIDAD CON HERRAJES EN ACERO INOXIDABLE
 COJINERIA DE ASIENTO(14CM) Y RESPALDO(17CM) COLOR CRUDO
 REQUIERE MONTAJE.

Aa(cm)	sh(in)	Ab(cm)	Ah(in)	Ae(cm)	Fh(in)	PN(kg)	NW(lb)
44,0	17,3	64,0	25,2	64,0	25,2	32,4	71,4
Ptos (pt)							1250



Ref.(code)
30100133

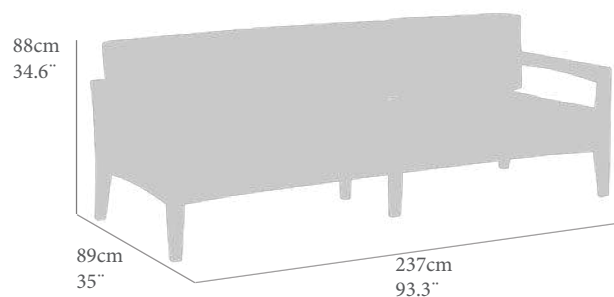

SOFÁ DE TRES PLAZAS MODELO VERNOM
 TECA DE PRIMERA CALIDAD CON HERRAJES EN ACERO INOXIDABLE
 COJINERIA DE ASIENTO(14CM) Y RESPALDO(17CM) COLOR CRUDO
 REQUIERE MONTAJE.

Aa(cm)	sh(in)	Ab(cm)	Ah(in)	Ae(cm)	Fh(in)	PN(kg)	NW(lb)
44,0	17,3	64,0	25,2	64,0	25,2	45,6	100,5
Ptos (pt)							1712



Ref.(code)
30100134

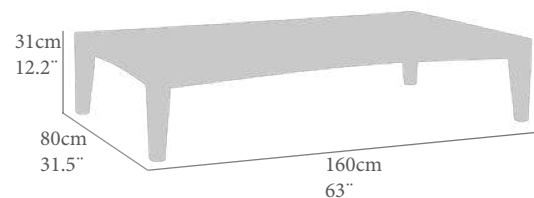

MESA AUXILIAR MODELO VERNOM
 TECA DE PRIMERA CALIDAD CON HERRAJES EN ACERO INOXIDABLE
 COJINERIA DE ASIENTO(14CM) Y RESPALDO(17CM) COLOR CRUDO
 REQUIERE MONTAJE.

GT(cm)	TT(in)	Al(cm)	FH(in)	PN(kg)	NW(lb)
2,5	1,0	24,0	9,4	10,0	22,0
Ptos (pt)					554



Ref.(code)
30100135

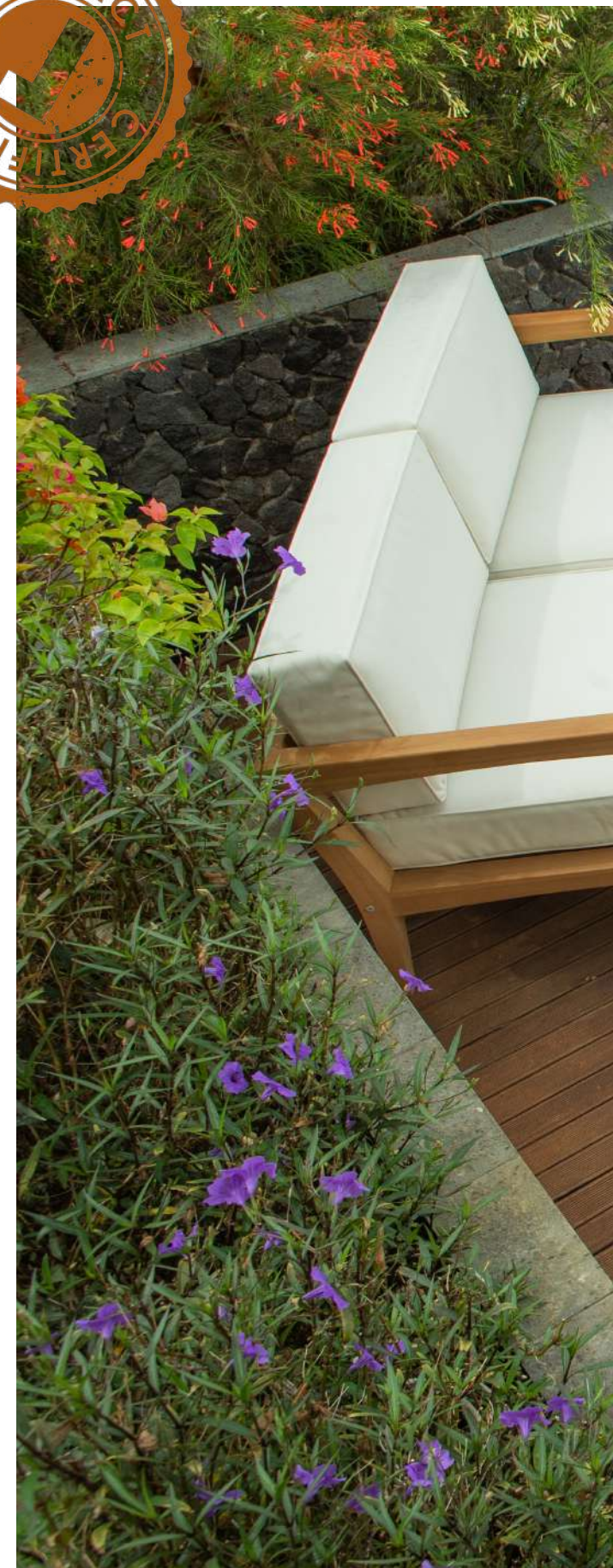

DETALLES / DETAILS
 182-183





DETALLES / DETAILS
182-183



DETALLES / DETAILS

182-183



120

AA/SH: Alt. asiento (Seat height) **AB/AH:** Alt. Brazo (Arm height) **AR/BH:** Alt. respaldo (Arm height) **AE/FH:** Alt. estruct. (Frame height) **GT/TT:** Grosor top (Top Thickness) **AL/FH:** Altura libre (Free top height) **PN/NW:** Peso neto (Net weight)

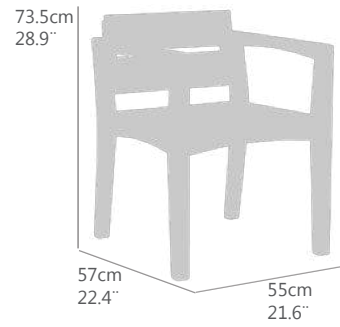

SILLA DE COMEDOR MODELO **VERNOM**

TECA DE PRIMERA CALIDAD CON HERRAJES EN ACERO INOXIDABLE

REQUIERE MONTAJE.

Aa(cm)	sh(in)	Ab(cm)	Ah(in)	Ae(cm)	Fh(in)	PN(kg)	NW(lb)	
44,0	17,3	66,0	26,0	73,5	28,9	13,0	28,7	
Ptos (pt)							252	

Teca

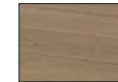

Natural SVTK01

Herrajes



Inox / Cromo

Ref.(code)
30100137

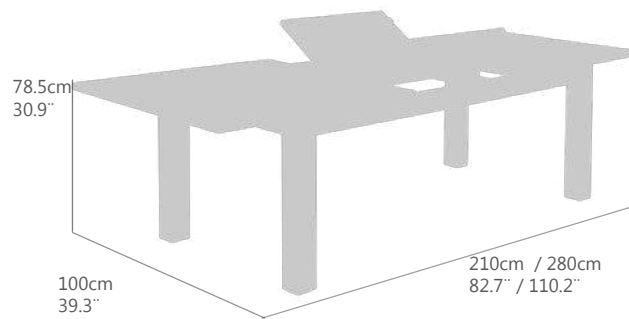

MESA DE COMEDOR EXTENSIBLE MODELO **VERNOM**

TECA DE PRIMERA CALIDAD CON HERRAJES EN ACERO INOXIDABLE

GUÍAS CORREDERAS EN ACERO INOXIDABLE

REQUIERE MONTAJE.

GT(cm)	TT(in)	Al(cm)	FH(in)	PN(kg)	NW(lb)
2,5	1,0	68	26,8	27,0	59,5
Ptos (pt)					1698

Teca



Natural SVTK01

Extensión



Guías metálicas

Herrajes



Inox / Cromo

Ref.(code)
30100136



DETALLES / DETAILS
182-183



TUMBONA MODELO VERNOM

TECA DE PRIMERA CALIDAD CON HERRAJES EN ACERO INOXIDABLE

RESPALDO REGULABLE EN 4 POSICIONES

DOBLE REFUERZO ENTRE LA ESTRUCTURA Y LAS PATAS

REQUIERE MONTAJE.

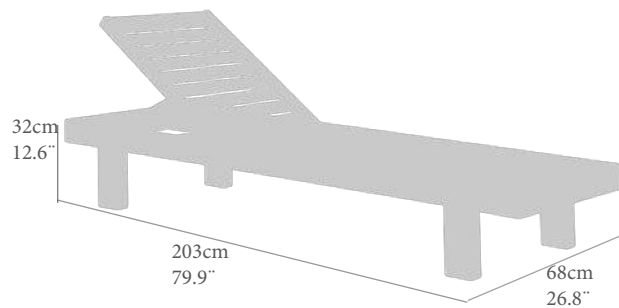

Aa(cm)	sh(in)	Ar(cm)	Bh(in)	Ae(cm)	Fh(in)	PN(kg)	NW(lb)
31,0	12,2	31/91	12,2/35,8			25,0	55,1
						Ptos (pt)	
						448	

Teca



Natural SVTK01

Ref.(code)
30100130

COJÍN PARA TUMBONA VERNOM (6 CM)

PN(kg)	NW(lb)
4,0	8,8
Ptos (pt)	
252	

Ref.(code)
30400089

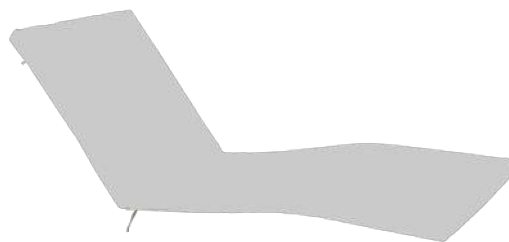



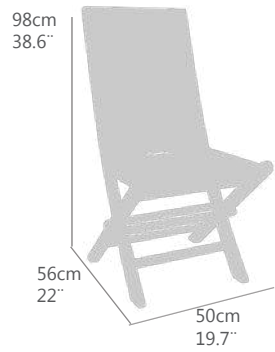

SILLA DE COMEDOR SUNNY

ESTRUCTURA EN TEGA DE PRIMERA CALIDAD

PLEGABLE

Aa(cm)	sh(in)	Ab(cm)	Ah(in)	Ae(cm)	Fh(in)	PN(kg)	NW(lb)
46,0	18,1			98,0	38,6	8,0	17,6
Ptos (pt)							104

Teca	Cojineria	Ref.(code)
		30100100
Natural SVTK01	Crudo SVTL14	

COJÍN PARA SILLA SUNNY COLOR CRUDO (4 CM)

PN(kg)	NW(lb)
1,4	3,1
Ptos (pt)	
130	

Ref.(code)
30100085

SILLA DE COMEDOR SUNNY

ESTRUCTURA EN TEGA DE PRIMERA CALIDAD

HERRAJES TERMINACIÓN LATÓN/INOXIDABLE

PLEGABLE

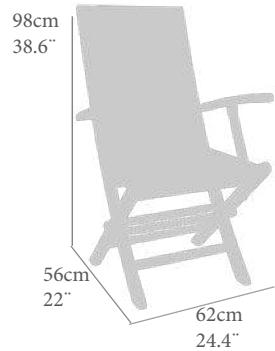

Aa(cm)	sh(in)	Ab(cm)	Ah(in)	Ae(cm)	Fh(in)	PN(kg)	NW(lb)
46,0	18,1	67,0	26,4	98,0	38,6	11,0	24,3
Ptos (pt)							148

Teca	Cojineria	Ref.(code)
		30100101
Natural SVTK01	Crudo SVTL14	

COJÍN PARA SILLA SUNNY COLOR CRUDO (4 CM)

PN(kg)	NW(lb)
1,4	3,1
Ptos (pt)	
130	

Ref.(code)
30100085

CARRO BAR DE TEGA

ESTRUCTURA EN TEGA DE PRIMERA CALIDAD

CON DOS BANDEJAS Y PORTA-BEBIDAS

RUEDAS DE TRANSPORTE

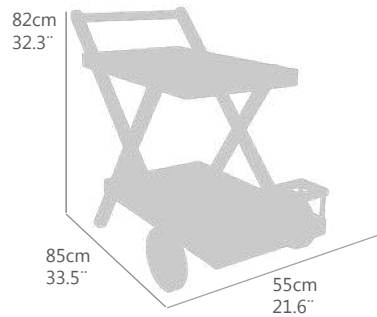

PN(kg)	NW(lb)
13,0	28,7
Ptos (pt)	
246	

Teca	Herrajes	Ref.(code)
		30600050
Natural SVTK01	Inox / Cromo	

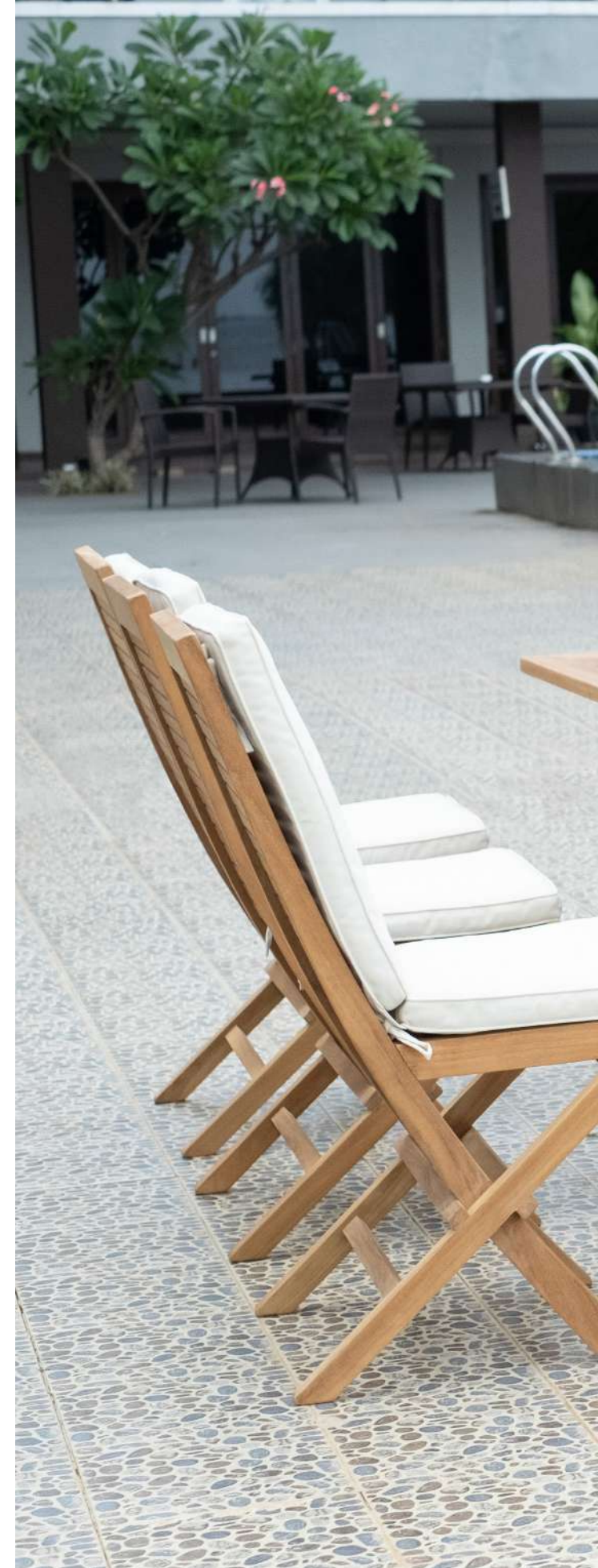



DETALLES / DETAILS
184-191

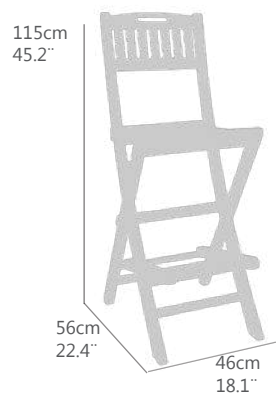

TABURETE ALTO PLEGABLE
 ESTRUCTURA EN TECA DE PRIMERA CALIDAD
 HERRAJES EN ACABADO INOXIDABLE
 REQUIERE MONTAJE

Aa(cm)	sh(in)	Ab(cm)	Ah(in)	Ae(cm)	Fh(in)	PN(kg)	NW(lb)
75,0	29,5			115,0	45,3	8,0	17,6
						Ptos (pt)	
						188	

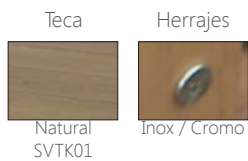

Ref.(code)
30600111

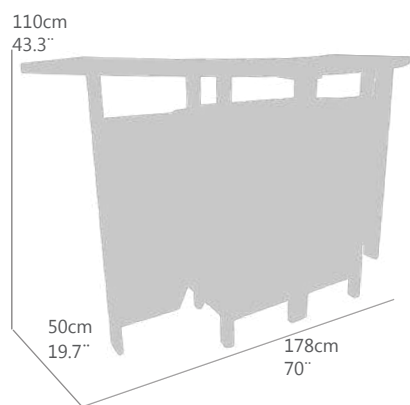

BARRA DE BAR
 ESTRUCTURA EN TECA DE PRIMERA CALIDAD
 ENCIMERA Y LATERALES PLEGABLES CON SISTEMA DE CIERRE
 DISPONE DE SISTEMA DE CIERRE, SISTEMA DE ALMACENAJE Y ORGANIZACIÓN INTERIOR

PN(kg)	NW(lb)
47,0	103,6
Ptos (pt)	
592	

MEDIDA PLEGADA: 95 X 54 X 110 cm.



Ref.(code)
30600053





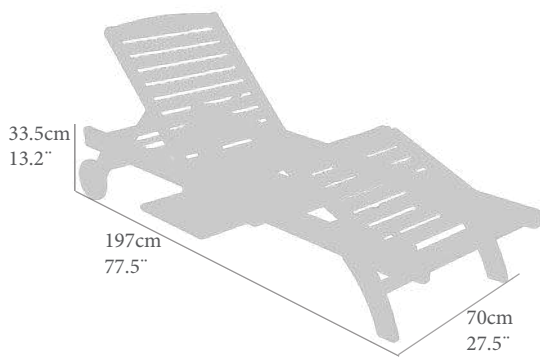

TUMBONA MODELO LAGUNA
 TECA DE PRIMERA CALIDAD CON HERRAJES EN LATÓN
 RESPALDO Y REPOSAPIÉS REGULABLES EN 4 POSICIONES
 CON BANDEJA EXTRAIBLE.
 COJINERIA (6CM) OPCIONAL
 REQUIERE MONTAJE.

Aa(cm)	sh(in)	Ar(cm)	Bh(in)	Ae(cm)	Fh(in)	PN(kg)	NW(lb)
33,5	13,2	33,5/91	13,2/35,8			30,0	66,1
						Ptos (pt)	532



Ref.(code)
30600081



CUJIN PARA TUMBONA LAGUNA

PN(kg)	NW(lb)
4,0	8,8
Ptos (pt)	
252	

Ref.(code)
30400069



DETALLES / DETAILS
 184-191







87cm
34.3"

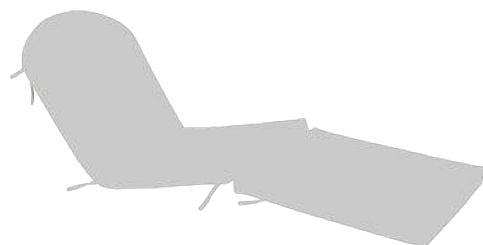
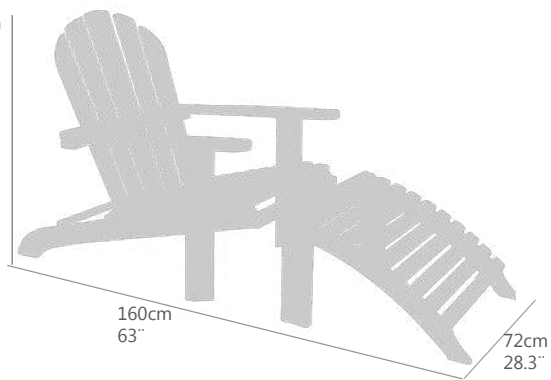

TUMBONA MODELO BANF

TECA DE PRIMERA CALIDAD CON HERRAJES EN LATÓN

SE COMPONE DE DOS PIEZAS (SILLÓN + REPOSAPIES)

REQUIERE MONTAJE

Aa(cm)	sh(in)	Ar(cm)	Bh(in)	Ae(cm)	Fh(in)	PN(kg)	NW(lb)
37,0	14,6	87,0	34,3	60,0	23,6	21,0	46,3
						Ptos (pt)	
						583	

Teca



Natural
SVTK01

Ref.(code)
30100131

COJÍN PARA TUMBONA BANF (6 cm)

PN(kg)	NW(lb)
3,6	7,9
Ptos (pt)	
250	

Ref.(code)
30400088

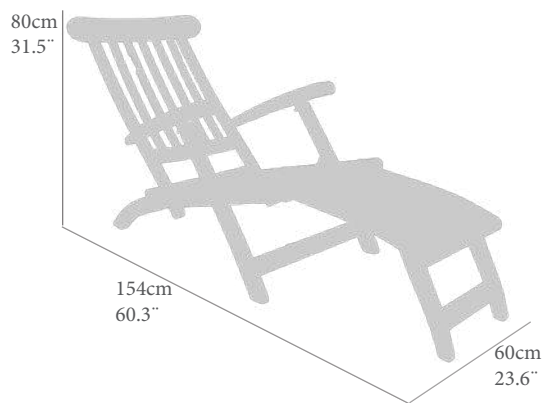

TUMBONA MODELO PRESIDENCIA

TECA DE PRIMERA CALIDAD CON HERRAJES EN LATÓN

RESPALDO MULTIPOSICIONES

COJINERIA (6CM) OPCIONAL.

PLEGABLE.

Aa(cm)	sh(in)	Ar(cm)	Bh(in)	Ae(cm)	Fh(in)	PN(kg)	NW(lb)
37,0	14,6	80-98	31,5-38,6	60,0	23,6	17,0	37,5
						Ptos (pt)	
						314	

Teca



Natural
SVTK01

Ref.(code)
30100078

COJÍN PARA TUMBONA PRESIDENCIAL

PN(kg)	NW(lb)
3,0	6,6
Ptos (pt)	
176	

Ref.(code)
30400070



DETALLES / DETAILS
184-191

PROTECCIÓN SILLAS / TABURETES



Cubierta 4-6 sillas apilable.
Cubierta Hidrofuga. **Tejido Ripstop alta durabilidad** con laminado transpirable. Doble costura interna. Tensores de ajuste en extremos para una mejor fijación. Color antracita.

REF.(CODE)	PTOS (PT)
30400100	34



Cubierta silla no apilable.
Cubierta Hidrofuga. **Tejido Ripstop alta durabilidad** con laminado transpirable. Doble costura interna. Tensores de ajuste en extremos para una mejor fijación. Color antracita.

REF.(CODE)	PTOS (PT)
30400440	30



PROTECCIÓN SILLÓN / SOFA



Cubierta sofa 1 plaza M
Cubierta Hidrofuga. **Tejido Ripstop alta durabilidad** con laminado transpirable. Doble costura interna. Tensores de ajuste en extremos para una mejor fijación. Color antracita.

REF.(CODE)	PTOS (PT)
30400443	36

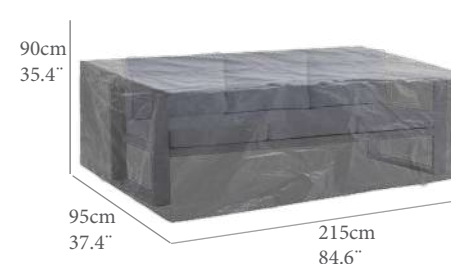

Cubierta sofa 3 plazas M
Cubierta Hidrofuga. **Tejido Ripstop alta durabilidad** con laminado transpirable. Doble costura interna. Tensores de ajuste en extremos para una mejor fijación. Color antracita.

REF.(CODE)	PTOS (PT)
30400446	54



Cubierta sofa 1 plaza L
Cubierta Hidrofuga. **Tejido Ripstop alta durabilidad** con laminado transpirable. Doble costura interna. Tensores de ajuste en extremos para una mejor fijación. Color antracita.

REF.(CODE)	PTOS (PT)
30400118	38



Cubierta sofa 2 plazas L
Cubierta Hidrofuga. **Tejido Ripstop alta durabilidad** con laminado transpirable. Doble costura interna. Tensores de ajuste en extremos para una mejor fijación. Color antracita.

REF.(CODE)	PTOS (PT)
30400445	48

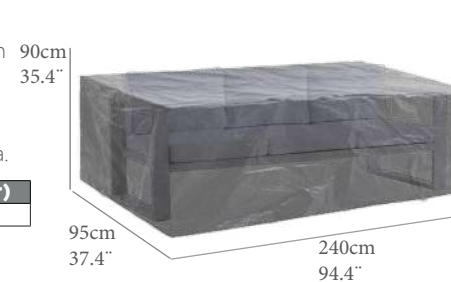

Cubierta sofa 3 plazas L
Cubierta Hidrofuga. **Tejido Ripstop alta durabilidad** con laminado transpirable. Doble costura interna. Tensores de ajuste en extremos para una mejor fijación. Color antracita.

REF.(CODE)	PTOS (PT)
30400448	58

PROTECCIÓN MESA ALTA / BAR

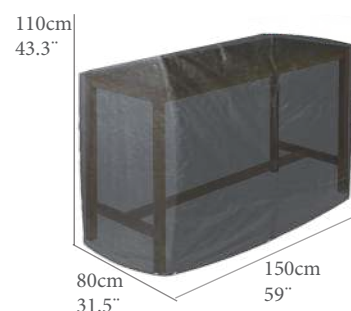

Cubierta mesa barra alta S
Cubierta Hidrofuga. **Tejido Ripstop alta durabilidad** con laminado transpirable. Doble costura interna. Tensores de ajuste en extremos para una mejor fijación. Color antracita.

REF.(CODE)	PTOS (PT)
30400461	52

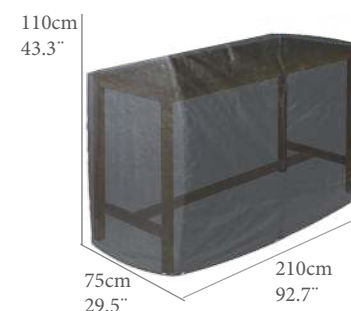

Cubierta mesa barra alta M
Cubierta Hidrofuga. **Tejido Ripstop alta durabilidad** con laminado transpirable. Doble costura interna. Tensores de ajuste en extremos para una mejor fijación. Color antracita.

REF.(CODE)	PTOS (PT)
30400466	56





Cubierta mesa rectangular.
Cubierta Hidrofuga. Tejido Ripstop alta durabilidad con laminado transpirable. Doble costura interna. Tensores de ajuste en extremos para una mejor fijación. Color antracita.

REF.(CODE)	PTOS (PT)
30400458	36

75cm 29.5"
125cm 49.2"
75cm 29.5"

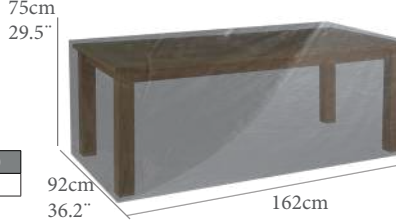

Cubierta mesa rectangular.
Cubierta Hidrofuga. Tejido Ripstop alta durabilidad con laminado transpirable. Doble costura interna. Tensores de ajuste en extremos para una mejor fijación. Color antracita.

REF.(CODE)	PTOS (PT)
30400108	44

75cm 29.5"
92cm 36.2"
162cm 63.8"

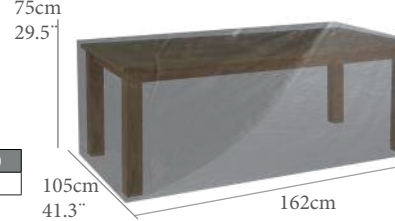

Cubierta mesa rectangular.
Cubierta Hidrofuga. Tejido Ripstop alta durabilidad con laminado transpirable. Doble costura interna. Tensores de ajuste en extremos para una mejor fijación. Color antracita.

REF.(CODE)	PTOS (PT)
30400103	46

75cm 29.5"
105cm 41.3"
162cm 63.8"

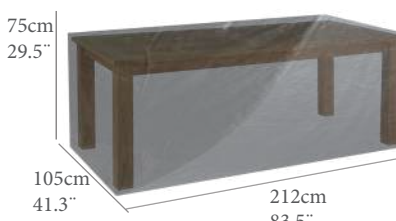

Cubierta mesa rectangular.
Cubierta Hidrofuga. Tejido Ripstop alta durabilidad con laminado transpirable. Doble costura interna. Tensores de ajuste en extremos para una mejor fijación. Color antracita.

REF.(CODE)	PTOS (PT)
30400105	52

75cm 29.5"
105cm 41.3"
212cm 83.5"



Cubierta mesa rectangular.
Cubierta Hidrofuga. Tejido Ripstop alta durabilidad con laminado transpirable. Doble costura interna. Tensores de ajuste en extremos para una mejor fijación. Color antracita.

REF.(CODE)	PTOS (PT)
30400106	54

75cm 29.5"
102cm 40.1"
223cm 87.8"

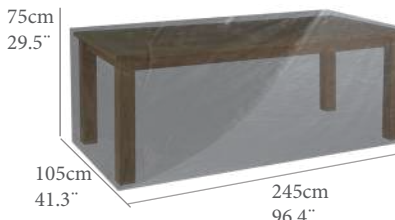

Cubierta mesa rectangular.
Cubierta Hidrofuga. Tejido Ripstop alta durabilidad con laminado transpirable. Doble costura interna. Tensores de ajuste en extremos para una mejor fijación. Color antracita.

REF.(CODE)	PTOS (PT)
30400459	58

75cm 29.5"
105cm 41.3"
245cm 96.4"



Cubierta mesa rectangular.
Cubierta Hidrofuga. Tejido Ripstop alta durabilidad con laminado transpirable. Doble costura interna. Tensores de ajuste en extremos para una mejor fijación. Color antracita.

REF.(CODE)	PTOS (PT)
30400107	60

75cm 29.5"
105cm 41.3"
285cm 112.2"



Cubierta mesa rectangular.
Cubierta Hidrofuga. Tejido Ripstop alta durabilidad con laminado transpirable. Doble costura interna. Tensores de ajuste en extremos para una mejor fijación. Color antracita.

REF.(CODE)	PTOS (PT)
30400122	56

80cm 31.5"
130cm 51.1"
191cm 75.2"

PROTECCIÓN MESAS DE COMEDOR CUADRADAS



Cubierta mesa cuadrada
Cubierta Hidrofuga. Tejido Ripstop alta durabilidad con laminado transpirable. Doble costura interna. Tensores de ajuste en extremos para una mejor fijación. Color antracita.

REF.(CODE)	PTOS (PT)
30400455	32

76cm 29.9"
75cm 29.5"
75cm 29.5"



Cubierta mesa cuadrada
Cubierta Hidrofuga. Tejido Ripstop alta durabilidad con laminado transpirable. Doble costura interna. Tensores de ajuste en extremos para una mejor fijación. Color antracita.

REF.(CODE)	PTOS (PT)
30400456	34

76cm 29.9"
85cm 33.5"
85cm 33.5"



Cubierta mesa cuadrada
Cubierta Hidrofuga. Tejido Ripstop alta durabilidad con laminado transpirable. Doble costura interna. Tensores de ajuste en extremos para una mejor fijación. Color antracita.

REF.(CODE)	PTOS (PT)
30400101	36

76cm 29.9"
92cm 36.2"
92cm 36.2"



PROTECCIÓN MESAS DE COMEDOR REDONDA



73cm
28.7"

Ø62cm
24.4"

Cubierta mesa redonda.
Cubierta Hidrofuga. Tejido Ripstop alta durabilidad con laminado transpirable. Doble costura interna. Tensores de ajuste en extremos para una mejor fijación. Color antracita.

REF.(CODE)	PTOS (PT)
30400460	26



73cm
28.7"

110cm
43.3"

Cubierta mesa redonda.
Cubierta Hidrofuga. Tejido Ripstop alta durabilidad con laminado transpirable. Doble costura interna. Tensores de ajuste en extremos para una mejor fijación. Color antracita.

REF.(CODE)	PTOS (PT)
30400109	38



73cm
28.7"

Ø125cm
49.2"

Cubierta mesa redonda.
Cubierta Hidrofuga. Tejido Ripstop alta durabilidad con laminado transpirable. Doble costura interna. Tensores de ajuste en extremos para una mejor fijación. Color antracita.

REF.(CODE)	PTOS (PT)
30400110	40



PROTECCIÓN MESA AUX.RECTANGULAR



43cm
16.9"

56cm 22.0" 108cm 42.5"

Cubierta mesa aux.rectang.S
Cubierta Hidrofuga. Tejido Ripstop alta durabilidad con laminado transpirable. Doble costura interna. Tensores de ajuste en extremos para una mejor fijación. Color antracita.

REF.(CODE)	PTOS (PT)
30400116	26



45cm
17.7"

65cm 25.6" 95cm 37.4"

Cubierta mesa aux.rectang.M
Cubierta Hidrofuga. Tejido Ripstop alta durabilidad con laminado transpirable. Doble costura interna. Tensores de ajuste en extremos para una mejor fijación. Color antracita.

REF.(CODE)	PTOS (PT)
30400452	26

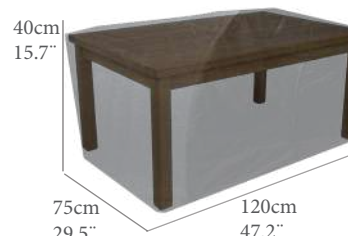

40cm
15.7"

75cm 29.5" 120cm 47.2"

Cubierta mesa aux.rectang.L
Cubierta Hidrofuga. Tejido Ripstop alta durabilidad con laminado transpirable. Doble costura interna. Tensores de ajuste en extremos para una mejor fijación. Color antracita.

REF.(CODE)	PTOS (PT)
30400115	28

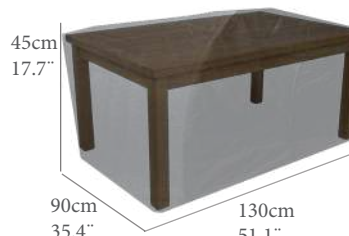

45cm
17.7"

90cm 35.4" 130cm 51.1"

Cubierta mesa aux.rectang.XL
Cubierta Hidrofuga. Tejido Ripstop alta durabilidad con laminado transpirable. Doble costura interna. Tensores de ajuste en extremos para una mejor fijación. Color antracita.

REF.(CODE)	PTOS (PT)
30400451	32

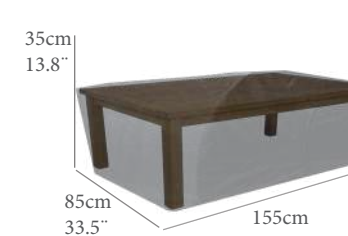

35cm
13.8"

85cm 33.5" 155cm 61"

Cubierta mesa aux.rectang.Baja
Cubierta Hidrofuga. Tejido Ripstop alta durabilidad con laminado transpirable. Doble costura interna. Tensores de ajuste en extremos para una mejor fijación. Color antracita.

REF.(CODE)	PTOS (PT)
30400464	32

PROTECCIÓN MESA AUX.CUADRADA

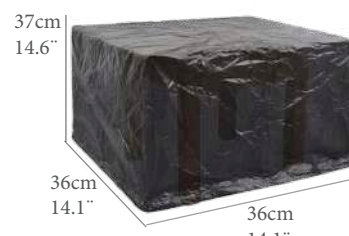

37cm
14.6"

36cm 14.1" 36cm 14.1"

Cubierta mesa aux.cuadrada.S
Cubierta Hidrofuga. Tejido Ripstop alta durabilidad con laminado transpirable. Doble costura interna. Tensores de ajuste en extremos para una mejor fijación. Color antracita.

REF.(CODE)	PTOS (PT)
30400454	18

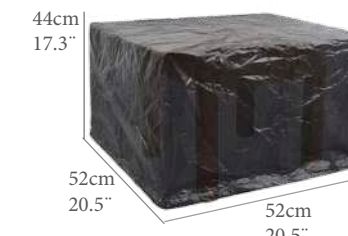

44cm
17.3"

52cm 20.5" 52cm 20.5"

Cubierta mesa aux.cuadrada.M
Cubierta Hidrofuga. Tejido Ripstop alta durabilidad con laminado transpirable. Doble costura interna. Tensores de ajuste en extremos para una mejor fijación. Color antracita.

REF.(CODE)	PTOS (PT)
30400114	22

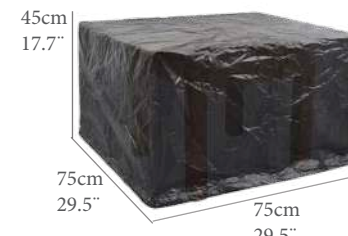

45cm
17.7"

75cm 29.5" 75cm 29.5"

Cubierta mesa aux.cuadrada.L
Cubierta Hidrofuga. Tejido Ripstop alta durabilidad con laminado transpirable. Doble costura interna. Tensores de ajuste en extremos para una mejor fijación. Color antracita.

REF.(CODE)	PTOS (PT)
30400463	26



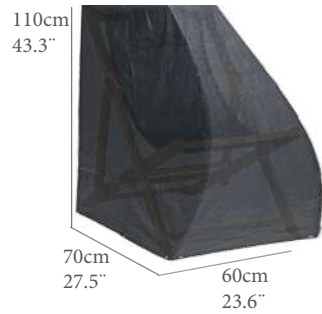

Cubierta mini tumbona
Cubierta Hidrofuga. Tejido Ripstop alta durabilidad con laminado transpirable. Doble costura interna. Tensores de ajuste en extremos para una mejor fijación. Color antracita.

REF.(CODE)	PTOS (PT)
30400450	32

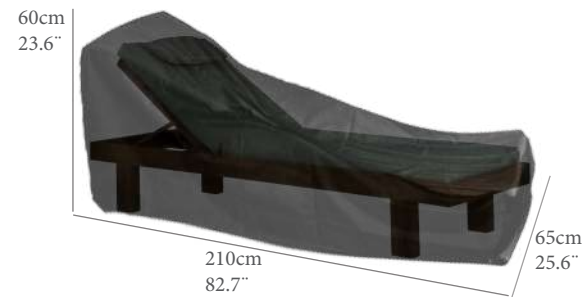

Cubierta tumbona apilable S
Cubierta Hidrofuga. Tejido Ripstop alta durabilidad con laminado transpirable. Doble costura interna. Tensores de ajuste en extremos para una mejor fijación. Color antracita.

REF.(CODE)	PTOS (PT)
30400449	42

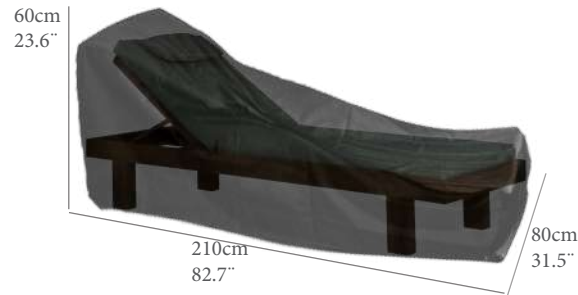

Cubierta tumbona apilable M
Cubierta Hidrofuga. Tejido Ripstop alta durabilidad con laminado transpirable. Doble costura interna. Tensores de ajuste en extremos para una mejor fijación. Color antracita.

REF.(CODE)	PTOS (PT)
30400112	44

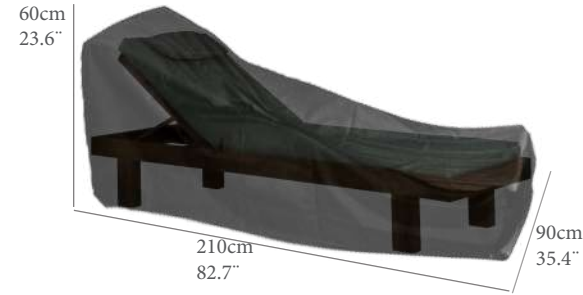

Cubierta tumbona apilable L
Cubierta Hidrofuga. Tejido Ripstop alta durabilidad con laminado transpirable. Doble costura interna. Tensores de ajuste en extremos para una mejor fijación. Color antracita.

REF.(CODE)	PTOS (PT)
30400113	46

PROTECCIÓN DAYBED

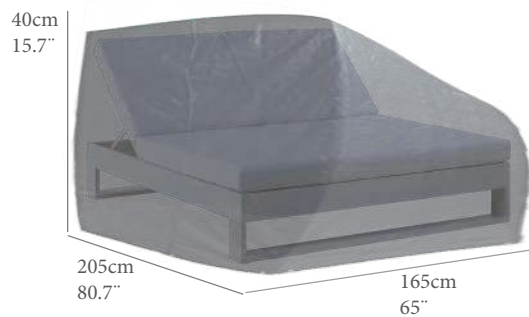

Cubierta para daybed.
Cubierta Hidrofuga. Tejido Ripstop alta durabilidad con laminado transpirable. Doble costura interna. Tensores de ajuste en extremos para una mejor fijación. Color antracita.

REF.(CODE)	PTOS (PT)
30400462	50

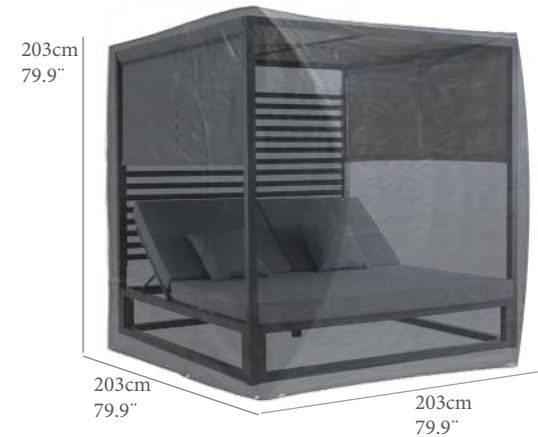

Cubierta para daybed con dosel
Cubierta Hidrofuga. Tejido Ripstop alta durabilidad con laminado transpirable. Doble costura interna. Tensores de ajuste en extremos para una mejor fijación. Color antracita.

REF.(CODE)	PTOS (PT)
30400111	118



Cubierta para daybed redondo M
Cubierta Hidrofuga. Tejido Ripstop alta durabilidad con laminado transpirable. Doble costura interna. Tensores de ajuste en extremos para una mejor fijación. Color antracita.

REF.(CODE)	PTOS (PT)
30400121	56



Cubierta para daybed redondo L
Cubierta Hidrofuga. Tejido Ripstop alta durabilidad con laminado transpirable. Doble costura interna. Tensores de ajuste en extremos para una mejor fijación. Color antracita.

REF.(CODE)	PTOS (PT)
30400120	68



PROTECCIÓN CONJUNTOS.

90cm
35.4"



Ø160cm
63"

Cubierta para set redondo M
Cubierta Hidrofuga. Tejido
Ripstop alta durabilidad con
laminado transpirable. Doble
costura interna. Tensores de
ajuste en extremos para una
mejor fijación. Color antracita.

REF.(CODE)	PTOS (PT)
30400469	52

90cm
35.4"



Ø200cm
78.7"

Cubierta para set redondo L
Cubierta Hidrofuga. Tejido
Ripstop alta durabilidad con
laminado transpirable. Doble
costura interna. Tensores de
ajuste en extremos para una
mejor fijación. Color antracita.

REF.(CODE)	PTOS (PT)
30400470	66

90cm
35.4"



160cm
63"

160cm
63"

Cubierta para set cuadrado M
Cubierta Hidrofuga. Tejido
Ripstop alta durabilidad con
laminado transpirable. Doble
costura interna. Tensores de
ajuste en extremos para una
mejor fijación. Color antracita.

REF.(CODE)	PTOS (PT)
30400471	60

90cm
35.4"



300cm
118"

300cm
118"

Cubierta para set cuadrado L
Cubierta Hidrofuga. Tejido
Ripstop alta durabilidad con
laminado transpirable. Doble
costura interna. Tensores de
ajuste en extremos para una
mejor fijación. Color antracita.

REF.(CODE)	PTOS (PT)
30400472	116

90cm
35.4"



160cm
63"

260cm
102.4"

Cubierta set rectangular M
Cubierta Hidrofuga. Tejido
Ripstop alta durabilidad con
laminado transpirable. Doble
costura interna. Tensores de
ajuste en extremos para una
mejor fijación. Color antracita.

REF.(CODE)	PTOS (PT)
30400473	76

90cm
35.4"



200cm
78.7"

300cm
118"

Cubierta set rectangular L
Cubierta Hidrofuga. Tejido
Ripstop alta durabilidad con
laminado transpirable. Doble
costura interna. Tensores de
ajuste en extremos para una
mejor fijación. Color antracita.

REF.(CODE)	PTOS (PT)
30400474	100

PROTECCIÓN AUXILIAR.

200cm
78.7"



Ø120cm
47.2"

Cubierta para balancin
Cubierta Hidrofuga. Tejido
Ripstop alta durabilidad con
laminado transpirable. Doble
costura interna. Tensores de
ajuste en extremos para una
mejor fijación. Color antracita.

REF.(CODE)	PTOS (PT)
30400477	60







TÉCNICO





Silla de comedor con brazos Apolo. Estructura en aluminio color antracita y textilene color gris medio..Brazos en polywood color teca. Alta resistencia a la intemperie. Apilable.

Aluminio		Textilene		Polywood	
					
Antracita SVAL4		Gris medio SVTX6		Teca SVPW02	
AA(cm)	SH(IN)	AB(cm)	AH(IN)	AE(cm)	FH(IN)
45	17.7	63	24.8	88	34.6
PN(kg)	NW(LB)	REF.(CODE)		PTOS (PT)	
3.6	7.9	30200864		252	



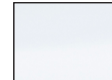

Silla de comedor con brazos Apolo. Estructura en aluminio color blanco y textilene color gris medio..Brazos en polywood color teca. Alta resistencia a la intemperie. Apilable.

Aluminio		Textilene		Polywood	
					
Blanco SVAL1		Gris medio SVTX6		Teca SVPW02	
AA(cm)	SH(IN)	AB(cm)	AH(IN)	AE(cm)	FH(IN)
45	17.7	63	24.8	88	34.6
PN(kg)	NW(LB)	REF.(CODE)		PTOS (PT)	
3.6	7.9	30200853		252	





Sillón director con brazos Apolo. Estructura en aluminio color antracita y textilene color gris medio..Brazos en polywood color teca. Alta resistencia a la intemperie. Plegable

Aluminio		Textilene		Polywood	
					
Antracita SVAL4		Gris medio SVTX6		Teca SVPW02	
AA(cm)	SH(IN)	AB(cm)	AH(IN)	AE(cm)	FH(IN)
45	17.7	63	24.8	88	34.6
PN(kg)	NW(LB)	REF.(CODE)		PTOS (PT)	
4.4	7.7	30200865		312	



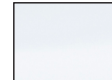

Sillón director con brazos Apolo. Estructura en aluminio color blanco y textilene color gris medio..Brazos en polywood color teca. Alta resistencia a la intemperie. Plegable

Aluminio		Textilene		Polywood	
					
Blanco SVAL1		Gris medio SVTX6		Teca SVPW02	
AA(cm)	SH(IN)	AB(cm)	AH(IN)	AE(cm)	FH(IN)
45	17.7	63	24.8	88	34.6
PN(kg)	NW(LB)	REF.(CODE)		PTOS (PT)	
4.4	7.7	30200854		312	



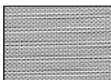

Sillón balancín con brazos Apolo. Estructura en aluminio color antracita y textilene color gris medio..Brazos en polywood color teca. Alta resistencia a la intemperie.

Aluminio		Textilene		Polywood	
					
Antracita SVAL4		Gris medio SVTX6		Teca SVPW02	
AA(cm)	SH(IN)	AB(cm)	AH(IN)	AE(cm)	FH(IN)
34/37	13.4/14.5	57	22.4	92	36.2
PN(kg)	NW(LB)	REF.(CODE)		PTOS (PT)	
5,2	11,4	30200871		358	



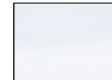
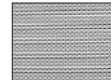

Sillón balancín con brazos Apolo. Estructura en aluminio color blanco y textilene color gris medio..Brazos en polywood color teca. Alta resistencia a la intemperie.

Aluminio		Textilene		Polywood	
					
Blanco SVAL1		Gris medio SVTX6		Teca SVPW02	
AA(cm)	SH(IN)	AB(cm)	AH(IN)	AE(cm)	FH(IN)
34/37	13.4/14.5	57	22.4	92	36.2
PN(kg)	NW(LB)	REF.(CODE)		PTOS (PT)	
5,2	11,4	30200860		358	



Reposapiés Apolo. Estructura en aluminio color antracita y textilene color gris medio.. Alta resistencia a la intemperie. Apilable.

Aluminio		Textilene			
					
Antracita SVAL4		Gris medio SVTX6			
AA(cm)	SH(IN)	AB(cm)	AH(IN)	AE(cm)	FH(IN)
32	12.6			32	12.6
PN(kg)	NW(LB)	REF.(CODE)		PTOS (PT)	
1,8	4	30200870		126	

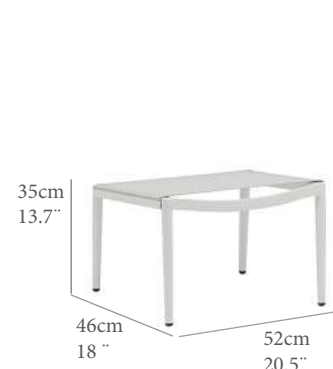

Reposapiés Apolo. Estructura en aluminio color blanco y textilene color gris medio.. Alta resistencia a la intemperie. Apilable.

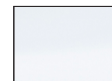
Aluminio		Textilene			
					
Blanco SVAL1		Gris medio SVTX6			
AA(cm)	SH(IN)	AB(cm)	AH(IN)	AE(cm)	FH(IN)
32	12.6			32	12.6
PN(kg)	NW(LB)	REF.(CODE)		PTOS (PT)	
1,8	4	30200859		126	



Sillón 1 plaza con brazos Apolo. Estructura en aluminio color antracita y textilene color gris medio.. Brazos en polywood color teca. Alta resistencia a la intemperie. Apilable.

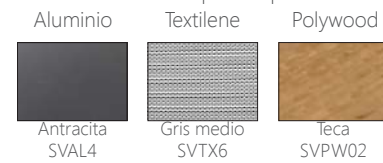

AA(cm)	SH(IN)	AB(cm)	AH(IN)	AE(cm)	FH(IN)
41	16.1	58	22.8	79	31.1
PN(kg)	NW(LB)	REF.(CODE)		PTOS (PT)	
4.4	7.7	30200868		302	



Sillón 1 plaza con brazos Apolo. Estructura en aluminio color blanco y textilene color gris medio.. Brazos en polywood color teca. Alta resistencia a la intemperie. Apilable.

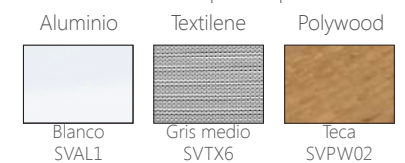

AA(cm)	SH(IN)	AB(cm)	AH(IN)	AE(cm)	FH(IN)
41	16.1	58	22.8	79	31.1
PN(kg)	NW(LB)	REF.(CODE)		PTOS (PT)	
4.4	7.7	30200857		302	



Sofá 2 plazas con brazos Apolo. Estructura en aluminio color antracita y textilene color gris medio..Brazos en polywood color teca. Alta resistencia a la intemperie. Apilable.

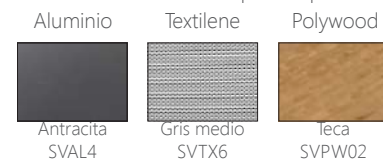

AA(cm)	SH(IN)	AB(cm)	AH(IN)	AE(cm)	FH(IN)
41	16.1	58	22.8	79	31.1
PN(kg)	NW(LB)	REF.(CODE)		PTOS (PT)	
6.6	14.5	30200869		488	



Sofá 2 plazas con brazos Apolo. Estructura en aluminio color blanco y textilene color gris medio..Brazos en polywood color teca. Alta resistencia a la intemperie. Apilable.

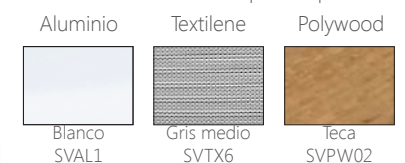

AA(cm)	SH(IN)	AB(cm)	AH(IN)	AE(cm)	FH(IN)
41	16.1	58	22.8	79	31.1
PN(kg)	NW(LB)	REF.(CODE)		PTOS (PT)	
6.6	14.5	30200858		488	



Mesa Auxiliar cuadrada modelo Apolo. Estructura en aluminio color antracita. Encimera en cristal cerámico de 8mm.Alt. resistencia a la intemperie. Requiere montaje.

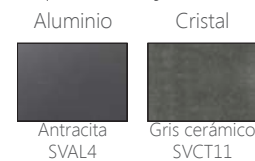

GT(cm)	TT(IN)	AL(cm)	FH(IN)	
8.0	3.14	39	15.3	
PN(kg)	NW(LB)	REF.(CODE)		PTOS (PT)
6	13.2	30200867		160



Mesa Auxiliar cuadrada modelo Apolo. Estructura en aluminio color blanco. Encimera en cristal cerámico de 8mm.Alt. resistencia a la intemperie. Requiere montaje.



GT(cm)	TT(IN)	AL(cm)	FH(IN)	
8.0	3.14	39	15.3	
PN(kg)	NW(LB)	REF.(CODE)		PTOS (PT)
6	13.2	30200856		160



Mesa Auxiliar rectangular modelo Apolo. Estructura en aluminio color antracita. Encimera en cristal cerámico de 8mm.Alt. resistencia a la intemperie. Requiere montaje.

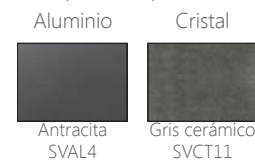

GT(cm)	TT(IN)	AL(cm)	FH(IN)	
8.0	3.14	39	15.3	
PN(kg)	NW(LB)	REF.(CODE)		PTOS (PT)
11	24.2	30200866		236





Mesa Auxiliar rectangular modelo Apolo. Estructura en aluminio color blanco. Encimera en cristal cerámico de 8mm.Alt. resistencia a la intemperie. Requiere montaje.



GT(cm)	TT(IN)	AL(cm)	FH(IN)	
8.0	3.14	39	15.3	
PN(kg)	NW(LB)	REF.(CODE)		PTOS (PT)
11	24.2	30200855		236



Mesa de comedor Apolo. Estructura en aluminio color antracita. Encimera en cristal cerámico de 8mm. Alta resistencia a la intemperie. Requiere montaje.

Aluminio		Cristal	
			
Antracita SVAL4	Gris cerámico SVCT11		
GT(cm)	TT(IN)	AL(cm)	FH(IN)
8.0	3.14	69.0	27.2
PN(kg)	NW(LB)	REF.(CODE)	PTOS (PT)
22	48.5	30200862	422



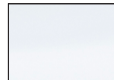
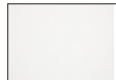

Mesa de comedor Apolo. Estructura en aluminio color blanco. Encimera en cristal cerámico de 8mm. Alta resistencia a la intemperie. Requiere montaje.

Aluminio		Cristal	
			
Blanco SVAL1	Ceram.Blanco SVCT14		
GT(cm)	TT(IN)	AL(cm)	FH(IN)
8.0	3.14	69.0	27.2
PN(kg)	NW(LB)	REF.(CODE)	PTOS (PT)
22	48.5	30200851	422



Mesa de comedor Apolo. Estructura en aluminio color antracita. Encimera en cristal cerámico de 8mm. Alta resistencia a la intemperie. Requiere montaje.

Aluminio		Cristal	
			
Antracita SVAL4	Gris cerámico SVCT11		
GT(cm)	TT(IN)	AL(cm)	FH(IN)
8.0	3.14	69.0	27.2
PN(kg)	NW(LB)	REF.(CODE)	PTOS (PT)
39.8	87.7	30200863	756

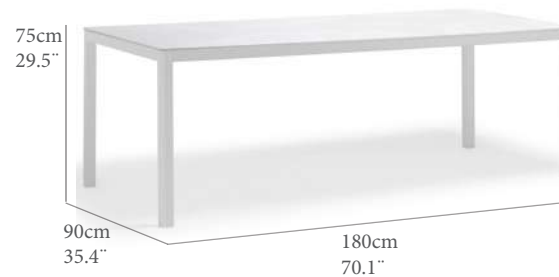

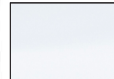
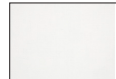

Mesa de comedor Apolo. Estructura en aluminio color blanco. Encimera en cristal cerámico de 3mm. Alta resistencia a la intemperie. Requiere montaje.

Aluminio		Cristal	
			
Blanco SVAL1	Ceram.Blanco SVCT14		
GT(cm)	TT(IN)	AL(cm)	FH(IN)
8.0	3.14	69.0	27.2
PN(kg)	NW(LB)	REF.(CODE)	PTOS (PT)
39.8	87.7	30200852	756





Mesa rectangular extensible Apolo. Estructura en aluminio color antracita. Encimera en cristal cerámico de 8mm. Extensible en HPL. Alta resistencia a la intemperie. Requiere montaje.

Aluminio		Cristal		HPL	
					
Antracita SVAL4	Gris cerámico SVCT11	leca SVPW02			
GT(cm)	TT(IN)	AL(cm)	FH(IN)		
8.0	3.14	68	26.8		
PN(kg)	NW(LB)	REF.(CODE)	PTOS (PT)		
80	176.4	30200861	2214		



Mesa rectangular extensible Apolo. Estructura en aluminio color blanco. Encimera en cristal cerámico de 8mm. Extensible en HPL. Alta resistencia a la intemperie. Requiere montaje.

Aluminio		Cristal		HPL	
					
Blanco SVAL1	Ceram.Blanco SVCT14	leca SVPW02			
GT(cm)	TT(IN)	AL(cm)	FH(IN)		
8.0	3.14	68	26.8		
PN(kg)	NW(LB)	REF.(CODE)	PTOS (PT)		
80	176.4	30200850	2214		



77cm
31"



78cm 245cm
30.7" 96.4"

Sofa 3 plazas Omi. Estructura en aluminio color antracita. Cojineria color Blanco **Con disposicion de plazas ajustable**. Madera de teca. Alta resistencia a la intemperie. Requiere montaje.

Aluminio	Textil	Madera
Antracita SVAL4	Blanco SVTL4	Teca SVTK01

AA(cm)	SH(IN)	AB(cm)	AH(IN)	AE(cm)	FH(IN)
37	14.6			71	27.9
PN(kg)	NW(LB)	REF.(CODE)	PTOS (PT)		
40	88	30200797	1360		

76cm
30"



245cm 78cm
96.4" 30.7"

Sofa esquinero Omi. Estructura en aluminio color antracita. Cojineria color Blanco. **Con disposicion de plazas ajustable**. Madera de teca. Alta resistencia a la intemperie. Requiere montaje.

Aluminio	Textil	Madera
Antracita SVAL4	Blanco SVTL4	Teca SVTK01

AA(cm)	SH(IN)	AB(cm)	AH(IN)	AE(cm)	FH(IN)
37	14.6			71	27.9
PN(kg)	NW(LB)	REF.(CODE)	PTOS (PT)		
40	88	30200798	1360		

Mesa de centro Omi. Estructura en aluminio color antracita. Encimera en madera de teca. Mesa movil superior color antracita. Alta resistencia a la intemperie.

Aluminio	Madera
Antracita SVAL4	Teca SVTK01

GT(cm)	TT(IN)	AL(cm)	FH(IN)
2	0.7	18	7
PN(kg)	NW(LB)	REF.(CODE)	PTOS (PT)
22	48.4	30200786	510

MESA AUXILIAR/COMEDOR CON MECANISMO AJUSTABLE

ESTRUCTURA EN ALUMINIO COLOR ANTRACITA

ENCIMERA DE MADERA FSC ACACIA

BASE DE ACERO: 1000x600-x8MM

ALTA RESISTENCIA A LA INTEMPERIE.

REQUIERE MONTAJE.

PN(kg)	NW(LB)
66	145,5
Ptos (pt)	1137

Aluminio	Madera
Antracita SVAL4	Teca SVTK01

Ref.(code)
30200097



Set rinconera Omi 3 piezas. Estructura en aluminio color antracita. Cojineria color Blanco. Madera de teca. Alta resistencia a la intemperie. Requiere montaje.

PN(kg)	NW(LB)	REF.(CODE)	PTOS (PT)
102	224.4	30200785	3172



36cm
14.1"

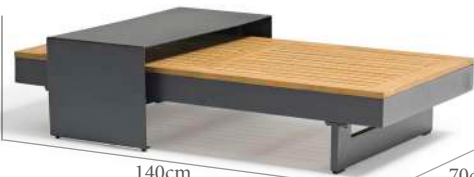

140cm 70cm
55" 27.5"

28cm
11"

45/65 cm
17.7' /25.6"



150 cm
59.0"

90 cm
35.4"



Silla con brazos modelo Concept. Aluminio color blanco y textilene color blanco puro. Apilable y de gran resistencia a la intemperie.



AA(cm)	SH(IN)	AB(cm)	AH(IN)	AE(cm)	FH(IN)
46,0	18,1	65,6	25,8	86,0	33,9
PN(kg)	NW(LB)	REF.(CODE)		PTOS (PT)	
3,3	7,3	30200309		118	



Silla con brazos modelo Concept. Aluminio color blanco y textilene color Gris claro. Apilable y de gran resistencia a la intemperie.

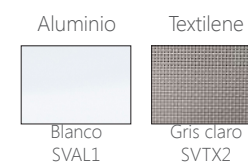

AA(cm)	SH(IN)	AB(cm)	AH(IN)	AE(cm)	FH(IN)
46,0	18,1	65,6	25,8	86,0	33,9
PN(kg)	NW(LB)	REF.(CODE)		PTOS (PT)	
3,3	7,3	30200360		118	



Silla con brazos modelo Concept. Aluminio color blanco y textilene color Taupe. Apilable y de gran resistencia a la intemperie.



AA(cm)	SH(IN)	AB(cm)	AH(IN)	AE(cm)	FH(IN)
46,0	18,1	65,6	25,8	86,0	33,9
PN(kg)	NW(LB)	REF.(CODE)		PTOS (PT)	
3,3	7,3	30200301		118	





Sillón Multiposición modelo Concept. Aluminio color blanco y textilene color blanco. Respaldo regulable en 5 posiciones. Plegable y de gran resistencia a la intemperie.



AA(cm)	SH(IN)	AR(cm)	BH(IN)	AB(cm)	AA(IN)
47,5	18,7	98-113	38,6/44,5	74,0	29,1
PN(kg)	NW(LB)	REF.(CODE)	PTOS (PT)		
5,5	12,1	30200268	212		



Sillón Multiposición modelo Concept. Aluminio color blanco y textilene color gris claro. Respaldo regulable en 5 posiciones. Plegable y de gran resistencia a la intemperie.

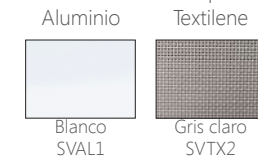

AA(cm)	SH(IN)	AR(cm)	BH(IN)	AB(cm)	AA(IN)
47,5	18,7	98-113	38,6/44,5	74,0	29,1
PN(kg)	NW(LB)	REF.(CODE)	PTOS (PT)		
5,5	12,1	30200271	212		



Sillón Multiposición modelo Concept. Aluminio color blanco y textilene color taupe. Respaldo regulable en 5 posiciones. Plegable y de gran resistencia a la intemperie.

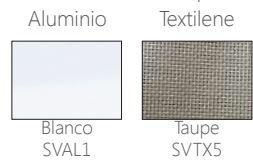

AA(cm)	SH(IN)	AR(cm)	BH(IN)	AB(cm)	AA(IN)
47,5	18,7	98-113	38,6/44,5	74,0	29,1
PN(kg)	NW(LB)	REF.(CODE)	PTOS (PT)		
5,5	12,1	30200269	212		



Sillón Multiposición modelo Concept. Aluminio color antracita y textilene color antracita. Respaldo regulable en 5 posiciones. Plegable y de gran resistencia a la intemperie.



AA(cm)	SH(IN)	AB(cm)	AH(IN)	AE(cm)	FH(IN)
47,5	18,7	74,0	29,1	98/113	38,6/44,5
PN(kg)	NW(LB)	REF.(CODE)	PTOS (PT)		
5,5	12,1	30200413	212		





Tumbona plegable modelo Boston. Aluminio color blanco y textilene color blanco puro. Respaldo regulable multiposicion.



AA(cm)	SH(IN)	AR(cm)	BH(IN)	AB(cm)	AA(IN)
32-39,5	12,6-15,5	63/81	24,8/31,9		
PN(kg)	NW(LB)	REF.(CODE)	PTOS (PT)		
5,9	13,0	30200312	240		



Tumbona plegable modelo Boston. Aluminio color blanco y textilene color Gris claro. Respaldo regulable multiposicion.

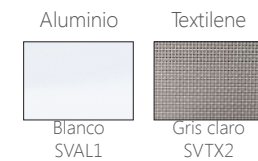

AA(cm)	SH(IN)	AR(cm)	BH(IN)	AB(cm)	AA(IN)
32-39,5	12,6-15,5	63/81	24,8/31,9		
PN(kg)	NW(LB)	REF.(CODE)	PTOS (PT)		
5,9	13,0	30200385	240		



Tumbona plegable modelo Boston. Aluminio color blanco y textilene color Taupe. Respaldo regulable multiposicion.

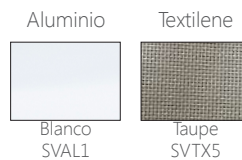

AA(cm)	SH(IN)	AR(cm)	BH(IN)	AB(cm)	AA(IN)
32-39,5	12,6-15,5	63/81	24,8/31,9		
PN(kg)	NW(LB)	REF.(CODE)	PTOS (PT)		
5,9	13,0	30200311	240		



Tumbona plegable modelo Boston. Aluminio color Taupe y textilene color Taupe. Respaldo regulable multiposicion.



AA(cm)	SH(IN)	AR(cm)	BH(IN)	AB(cm)	AA(IN)
32-39,5	12,6-15,5	63/81	24,8/31,9		
PN(kg)	NW(LB)	REF.(CODE)	PTOS (PT)		
5,9	13,0	30200387	240		



Tumbona plegable modelo Boston. Aluminio color gris Antracita y textilene color gris Antracita. Respaldo regulable multiposicion.

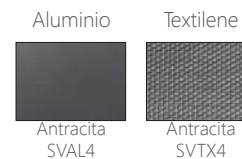

AA(cm)	SH(IN)	AR(cm)	BH(IN)	AB(cm)	AA(IN)
32-39,5	12,6-15,5	63/81	24,8/31,9		
PN(kg)	NW(LB)	REF.(CODE)	PTOS (PT)		
5,9	13,0	30200388	240		



Tumbona modelo Atena. Estructura de Aluminio color blanco y textilene color blanco. Respaldo regulable en 5 posiciones. Apilable.

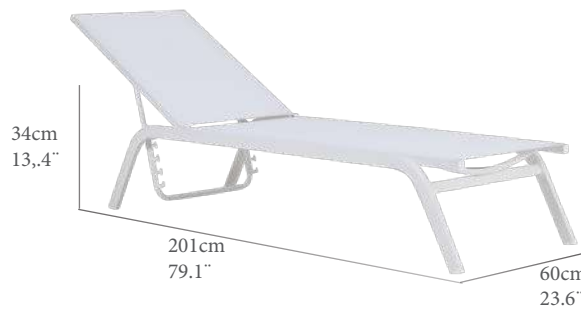

Aluminio		Textilene			
	Blanco SVAL1		Blanco SVTX1		
AA(cm)	SH(IN)	AR(cm)	BH(IN)	AB(cm)	AA(IN)
34,0	13,4	34/101	13,4/39,8		
PN(kg)	NW(LB)	REF.(CODE)	PTOS (PT)		
6,7	14,8	30200377	220		

Tumbona modelo Atena. Estructura de Aluminio color blanco y textilene color gris claro. Respaldo regulable en 5 posiciones. Apilable.

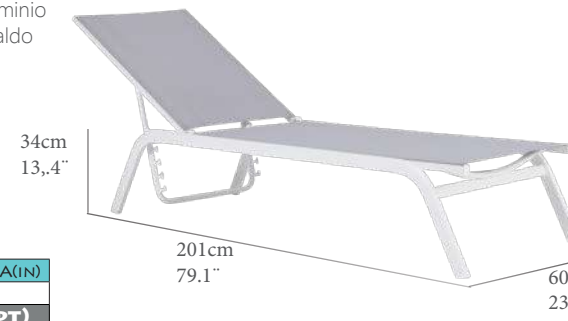

Aluminio		Textilene			
	Blanco SVAL1		Gris claro SVTX2		
AA(cm)	SH(IN)	AR(cm)	BH(IN)	AB(cm)	AA(IN)
34,0	13,4	34/101	13,4/39,8		
PN(kg)	NW(LB)	REF.(CODE)	PTOS (PT)		
6,7	14,8	30200380	220		

Tumbona modelo Atena. Estructura de Aluminio color blanco y textilene color taupe. Respaldo regulable en 5 posiciones. Apilable.

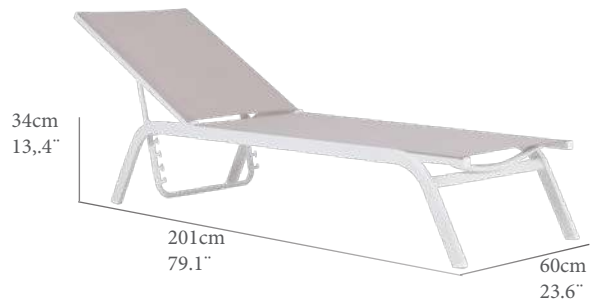

Aluminio		Textilene			
	Blanco SVAL1		taupe SVTX5		
AA(cm)	SH(IN)	AR(cm)	BH(IN)	AB(cm)	AA(IN)
34,0	13,4	34/101	13,4/39,8		
PN(kg)	NW(LB)	REF.(CODE)	PTOS (PT)		
6,7	14,8	30200378	220		

Tumbona modelo Atena. Estructura de Aluminio color taupe y textilene color taupe. Respaldo regulable en 5 posiciones. Apilable.

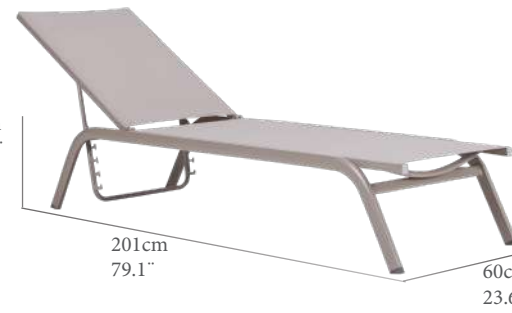

Aluminio		Textilene			
	taupe SVAL3		taupe SVTX5		
AA(cm)	SH(IN)	AR(cm)	BH(IN)	AB(cm)	AA(IN)
34,0	13,4	34/101	13,4/39,8		
PN(kg)	NW(LB)	REF.(CODE)	PTOS (PT)		
6,7	14,8	30200382	220		

Tumbona modelo Atena. Estructura de Aluminio color gris antracita y textilene color gris antracita. Respaldo regulable en 5 posiciones. Apilable.

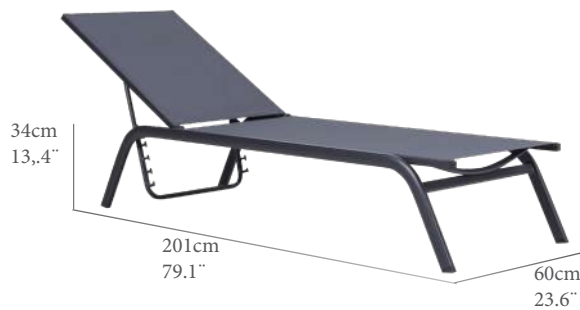

Aluminio		Textilene			
	Antracita SVAL4		Antracita SVTX4		
AA(cm)	SH(IN)	AR(cm)	BH(IN)	AB(cm)	AA(IN)
34,0	13,4	34/101	13,4/39,8		
PN(kg)	NW(LB)	REF.(CODE)	PTOS (PT)		
6,7	14,8	30200383	220		



Tumbona modelo Curve. Estructura de Aluminio color blanco y textilene color blanco. Respaldo regulable en 5 posiciones y ruedas de transporte ocultas. Apilable.

Aluminio Textilene



Blanco SVAL1 Blanco SVTX1

AA(cm)	SH(IN)	AR(cm)	BH(IN)	AB(cm)	AA(IN)
31,0	12,2	31/95	12,2/37,4		
PN(kg)	NW(Lb)	REF.(CODE)	PTOS (PT)		
12,5	27,6	30200314	520		

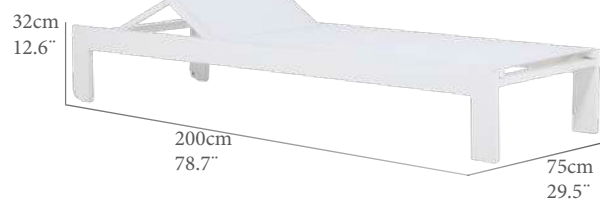

Tumbona modelo Curve. Estructura de Aluminio color blanco y textilene color gris claro. Respaldo regulable en 5 posiciones y ruedas de transporte ocultas. Apilable.

Aluminio Textilene



Blanco SVAL1 Gris claro SVTX2

AA(cm)	SH(IN)	AR(cm)	BH(IN)	AB(cm)	AA(IN)
31,0	12,2	31/95	12,2/37,4		
PN(kg)	NW(Lb)	REF.(CODE)	PTOS (PT)		
12,5	27,6	30200373	520		

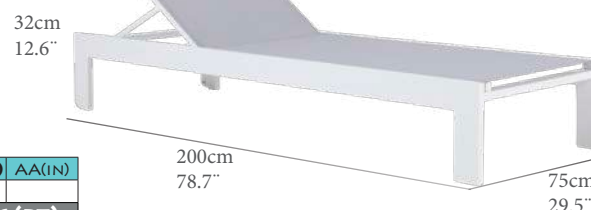

Tumbona modelo Curve. Estructura de Aluminio color blanco y textilene color taupe. Respaldo regulable en 5 y ruedas de transporte ocultas posiciones. Apilable.

Aluminio Textilene

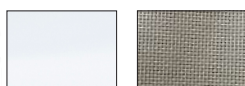

Blanco SVAL1 taupe SVTX5

AA(cm)	SH(IN)	AR(cm)	BH(IN)	AB(cm)	AA(IN)
31,0	12,2	31/95	12,2/37,4		
PN(kg)	NW(Lb)	REF.(CODE)	PTOS (PT)		
12,5	27,6	30200308	520		



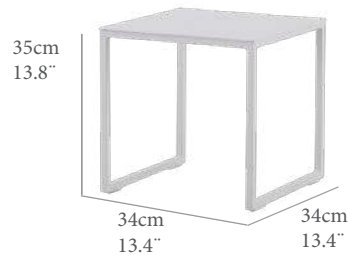

Mesa Auxiliar modelo Oslo. Estructura de aluminio color blanco y encimera en aluminio color blanco.



GT(cm)	TT(IN)	AL(cm)	FH(IN)
0,3	0,1	33,0	13,0
PN(kg)	NW(LB)	REF.(CODE)	PTOS (PT)
1,7	3,7	30200324	88

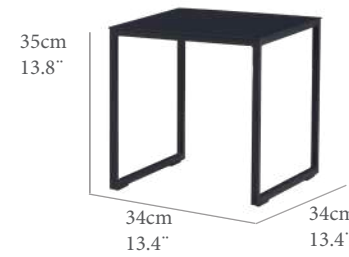

Mesa Auxiliar modelo Oslo. Estructura de aluminio color gris Antracita y encimera en aluminio color gris Antracita.



GT(cm)	TT(IN)	AL(cm)	FH(IN)
0,3	0,1	33,0	13,0
PN(kg)	NW(LB)	REF.(CODE)	PTOS (PT)
1,7	3,7	30200281	88



Mesa auxiliar modelo Hadar. Estructura de Aluminio color blanco Top en aluminio laminado 5mm.. Alta resistencia a la intemperie.



GT(cm)	TT(IN)	AL(cm)	FH(IN)
0,3	0,1	45,0	17,7
PN(kg)	NW(LB)	REF.(CODE)	PTOS (PT)
3,9	8,6	30200872	220



Mesa Auxiliar modelo June. Estructura de aluminio color blanco y encimera en aluminio color blanco.



GT(cm)	TT(IN)	AL(cm)	FH(IN)
0,5	0,2	54,5	21,5
PN(kg)	NW(LB)	REF.(CODE)	PTOS (PT)
5,3	11,7	30200267	140



Mesa auxiliar modelo Hadar. Estructura de Aluminio color blanco Top en aluminio laminado 5mm.. Alta resistencia a la intemperie.



GT(cm)	TT(IN)	AL(cm)	FH(IN)
0,3	0,1	40,0	15,7
PN(kg)	NW(LB)	REF.(CODE)	PTOS (PT)
5,0	11,0	30200873	264



Mesa auxiliar modelo Hadar. Estructura de Aluminio color antracita Top en aluminio laminado 5mm.. Alta resistencia a la intemperie.



GT(cm)	TT(IN)	AL(cm)	FH(IN)
0,3	0,1	45,0	17,7
PN(kg)	NW(LB)	REF.(CODE)	PTOS (PT)
3,9	8,6	30200840	220



Mesa auxiliar modelo Hadar. Estructura de Aluminio color antracita Top en aluminio laminado 5mm.. Alta resistencia a la intemperie.



GT(cm)	TT(IN)	AL(cm)	FH(IN)
0,3	0,1	40,0	15,7
PN(kg)	NW(LB)	REF.(CODE)	PTOS (PT)
5,0	11,0	30200841	264

200cm
78.7"



198cm
77.9"

198cm
77.9"

Daybed modelo Concept. Estructura de aluminio pintada en color blanco. Respaldo con dos zonas regulación independientes. Cubierta superior con regulación lateral en poliéster reforzado con Teflón. Terminación del colchón en polipiel náutica y textilene en la parte inferior para una fácil evacuación.

AA(cm)	SH(IN)	AR(cm)	BH(IN)	AB(cm)	AA(IN)
45,0	17,7	45/96	17,7/37,8		
PN(kg)	NW(LB)	REF.(CODE)	PTOS (PT)		
63,0	138,9	30200225	2100		

Aluminio

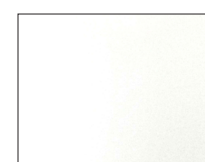

Blanco
SVAL1

Polipiel



Nautico blanco
SVTL1



200cm
78.7"

198cm
77.9"

198cm
77.9"

Daybed modelo **Concept-style**. Estructura de aluminio pintada en color blanco. **Trasera con Kit de reducción solar trasera**. Respaldo con dos zonas regulación independientes. Cubierta superior con regulación lateral en tela acrílica. Colchón en polipiel náutica con grosor de 12centímetros. Sistema inferior de drenaje y transpiración. Desenfundable. Cojines auxiliares incluidos

AA(cm)	SH(IN)	AR(cm)	BH(IN)	AB(cm)	AA(IN)
45,0	17,7	45/96	17,7/37,8		
PN(kg)	NW(LB)	REF.(CODE)	PTOS (PT)		
78,0	172,0	33000010	2480		

Aluminio

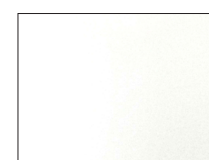

Blanco
SVAL1

Polipiel



Nautico blanco
SVTL1



Daybed modelo Concept exclusive. Estructura de aluminio pintada en color taupe. Respaldo con dos zonas regulación independientes. Cubierta superior con regulación lateral en poliéster reforzado con Teflón. Colchón en tela acrílica de alta calidad con alta capacidad del evacuación. y grosor de 12cm color taupe.

AA(cm)	SH(IN)	AR(cm)	BH(IN)	AB(cm)	AA(IN)
45,0	17,7	45/96	17,7/37,8		
PN(kg)	NW(LB)	REF.(CODE)	PTOS (PT)		
63,0	138,9	33000003	2858		



Daybed modelo **Concept-style**. Estructura de aluminio pintada en color taupe. **Trasera con Kit de reducción solar trasera**. Respaldo con dos zonas regulación independientes. Cubierta superior con regulación lateral en tela acrílica. Colchón en tela acrílica de alta calidad con alta capacidad del evacuación. y grosor de 12cm color taupe. Sistema inferior de drenaje y transpiración. Desenfundable. Cojines auxiliares incluidos

AA(cm)	SH(IN)	AR(cm)	BH(IN)	AB(cm)	AA(IN)
45,0	17,7	45/96	17,7/37,8		
PN(kg)	NW(LB)	REF.(CODE)	PTOS (PT)		
78,0	172,0	33000030	3258		





Daybed modelo **Concept exclusive**. Estructura de aluminio pintada en color antracita. Respaldo con dos zonas regulación independientes. Cubierta superior con regulación lateral en poliéster reforzado con Teflón. Colchón en tela acrílica de alta calidad con alta capacidad del evacuación, y grosor de 12cm color antracita

AA(cm)	SH(IN)	AR(cm)	BH(IN)	AB(cm)	AA(IN)
45,0	17,7	45/96	17,7/37,8		
PN(kg)	NW(Lb)	REF.(CODE)	PTOS (PT)		
63,0	138,9	33000005	2858		

Aluminio

Textil



Antracita
SVAL4

Gris CARTENZA



Daybed modelo **Concept-style**. Estructura de aluminio pintada en color antracita. **Trasera con Kit de reducción solar trasera**. Respaldo con dos zonas regulación independientes. Cubierta superior con regulación lateral en tela acrílica. Colchón en tela acrílica de alta calidad con alta capacidad del evacuación, y grosor de 12cm color antracita. Sistema inferior de drenaje y transpiración. Desenfundable. Cojines auxiliares incluidos

AA(cm)	SH(IN)	AR(cm)	BH(IN)	AB(cm)	AA(IN)
45,0	17,7	45/96	17,7/37,8		
PN(kg)	NW(Lb)	REF.(CODE)	PTOS (PT)		
78,0	172,0	33000035	3258		

Aluminio

Textil

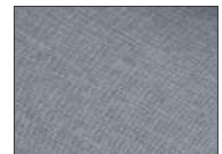

Antracita
SVAL4

Gris CARTENZA

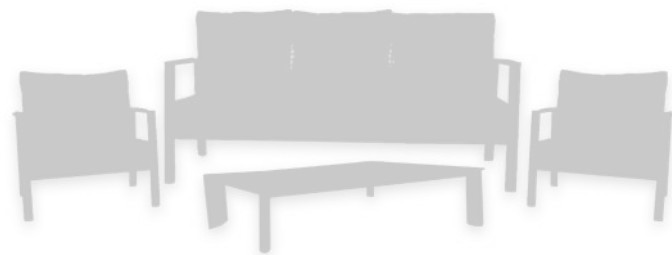

SET DE SOFÁ MODELO FOX
 ESTRUCTURA EN ALUMINIO COLOR ANTRACITA CON BRAZOS EN TECA
 COJÍN DE ASIENTO (10 CM) Y RESPALDO (10 CM).
 TEXTIL OLIFINE JASPEADO
 CUERDA FINA TRENZADA DE ALTA CALIDAD
 MESA RECTANGULAR CON ESTRUCTURA DE ALUMINIO
 ENCIMERA DE PIEDRA SINTERIZADA COLOR ANTRACITA

Ptos (pt)

3336

Aluminio



Antracita
SVAL4

Textil



South End
161

Cuerda



R6
ED19

Ref.(code)
30201050

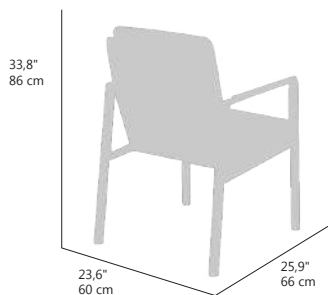
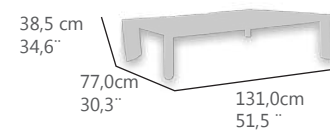
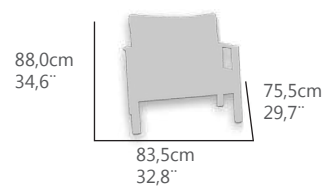
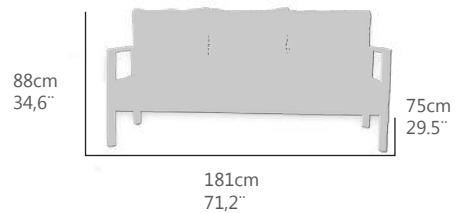

SILLA DE COMEDOR MODELO FOX
 ESTRUCTURA EN ALUMINIO COLOR ANTRACITA
 CON BRAZOS EN TECA
 COJÍN DE ASIENTO (5 CM) Y RESPALDO (5 CM)
 TEXTIL OLIFINE JASPEADO
 CUERDA FINA TRENZADA DE ALTA CALIDAD
 NO APILABLE

Aluminio



Antracita
SVAL4

Textil



Gris tempo
SVTX9

Ref.(code)
30201014

Ptos (pt)

378

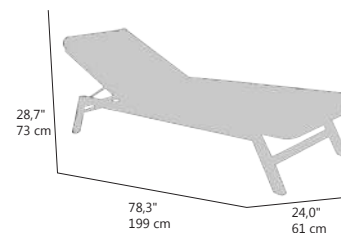

TUMBONA MODELO FOX
 ESTRUCTURA DE ALUMINIO COLOR ANTRACITA
 COJÍN DE ASIENTO (8 CM) Y RESPALDO (8 CM)
 TEXTIL OLIFINE JASPEADO
 CUERDA FINA TRENZADA DE ALTA CALIDAD.
 NO APILABLE.
 ALTA RESISTENCIA A LA INTEMPERIE.

SIN BRAZOS

Aluminio



Antracita
SVAL4

Textil



Gris tempo
SVTX9

Ref.(code)
30201059

Ptos (pt)

814

SET DE SOFÁ MODELO BALI CLASSIC
 ESTRUCTURA EN ALUMINIO COLOR ANTRACITA Y COJÍN DE ASIENTO (12 CM) Y RESPALDO (12 CM)
 TEXTIL OLIFINE JASPEADO
 CUERDA PLANA TRENZADA DE ALTA CALIDAD
 MESAS REDONDAS AUXILIARES ALUMINIO COLOR ANTRACITA

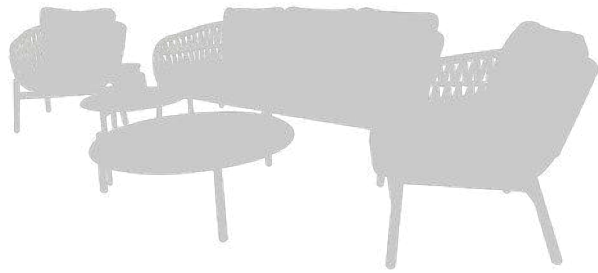

Ptos (pt)
3609



Ref.(code)
30201030

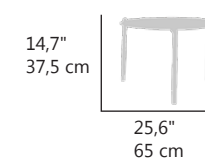
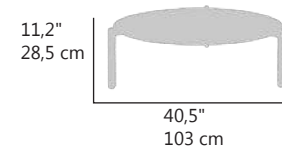
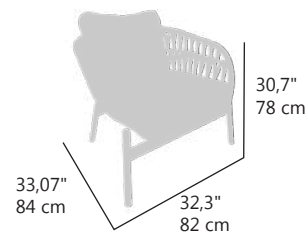
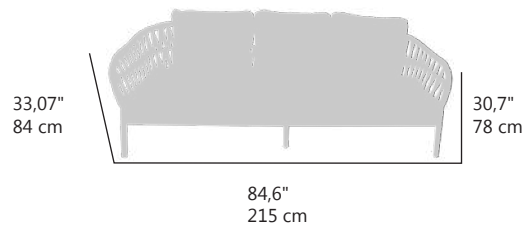

SILLA DE COMEDOR MODELO BALI CLASSIC
 ESTRUCTURA DE ALUMINIO COLOR ANTRACITA
 COJÍN DE ASIENTO (5 CM) Y RESPALDO (5 CM)
 TEXTIL OLIFINE JASPEADO
 CUERDA PLANA TRENZADA DE ALTA CALIDAD
 NO APILABLE.

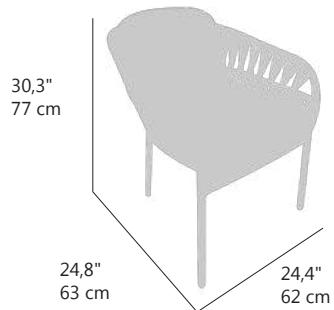

Ptos (pt)
345



Ref.(code)
30201030

MESA DE COMEDOR BALI CLASSIC
 ESTRUCTURA EN ALUMINIO COLOR ANTRACITA
 ENCIMERA ANTRACITA DE PIEDRA SINTERIZADA DE 12 MM
 PATAS MACIZAS TIPO MARIPOSA
 ALTA RESISTENCIA A LA INTEMPERIE
 REQUIERE MONTAJE

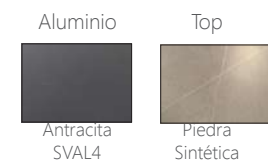
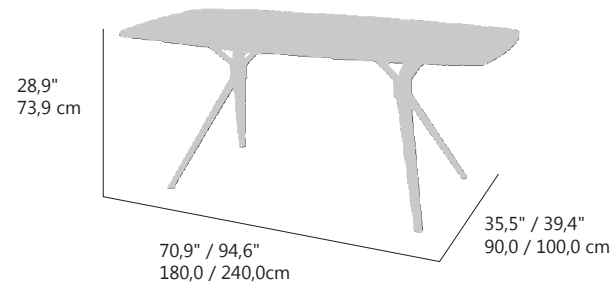

180*90*73,9 cm Ref.(code)
30201036

Ptos (pt)
1522

240*100*73,9 cm Ref.(code)
30201027

Ptos (pt)
1950

MESA DE COMEDOR BALI CLASSIC
 ESTRUCTURA EN ALUMINIO COLOR BLANCO
 ENCIMERA BLANCA DE PIEDRA SINTERIZADA DE 12 MM
 PATAS MACIZAS TIPO MARIPOSA
 ALTA RESISTENCIA A LA INTEMPERIE
 REQUIERE MONTAJE

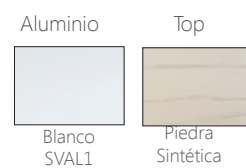
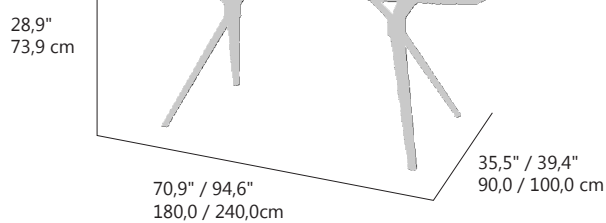

180*90*73,9 cm Ref.(code)
30201037

Ptos (pt)
1522

240*100*73,9 cm Ref.(code)
30201026

Ptos (pt)
1950

SET DE SOFÁ MODELO TANGO

ESTRUCTURA EN ALUMINIO COLOR BLANCO
COJÍN DE ASIENTO (10 CM) Y RESPALDO (10 CM)
TEXTIL OLIFINE JASPEADO
CUERDA REDONDA TRENZADA DE ALTA CALIDAD
MESA AUXILIAR RECTANGULAR CON ESTRUCTURA DE ALUMINIO BLANCO Y ENCIMERA DE PIEDRA SINTERIZADA REQUIERE MONTAJE

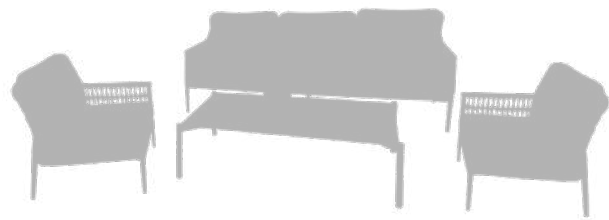

Ptos (pt)
3355

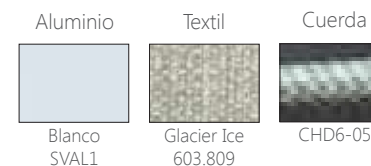

Ref.(code)
30201000

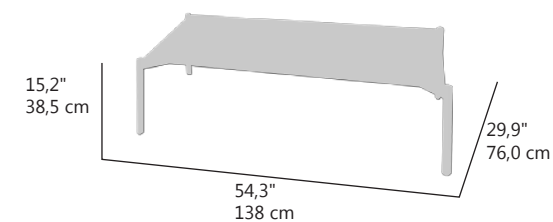
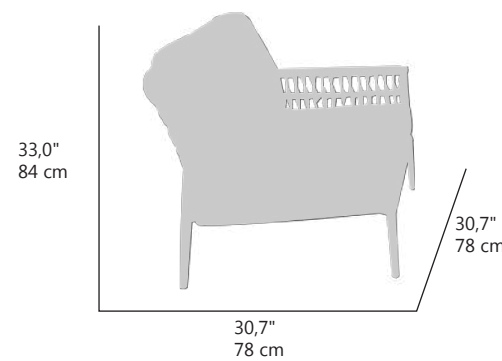
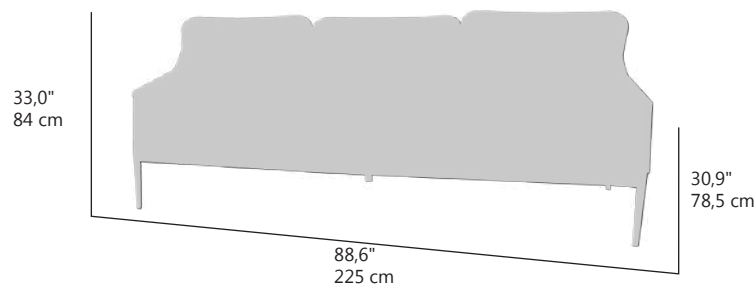

TUMBONA CON BRAZOS MODELO TANGO
ESTRUCTURA DE ALUMINIO COLOR BLANCO Y COJIN DE 8CM
TEXTIL OLIFINE JASPEADO
CUERDA REDONDA TRENZADA DE ALTA CALIDAD
NO APILABLE
REQUIERE MONTAJE

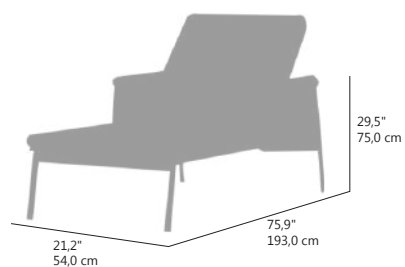

Ptos (pt)
736



Ref.(code)
30201012

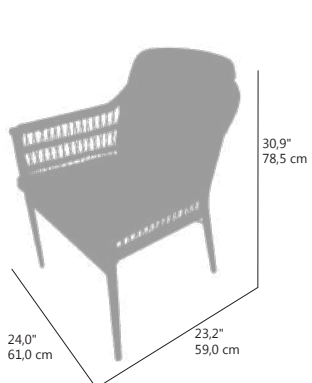

SILLA DE COMEDOR MODELO TANGO
ESTRUCTURA DE ALUMINIO COLOR BLANCO
COJÍN DE ASIENTO (5 CM) Y RESPALDO (5 CM)
TEXTIL OLIFINE JASPEADO
CUERDA REDONDA TRENZADA DE ALTA CALIDAD
APILABLE.

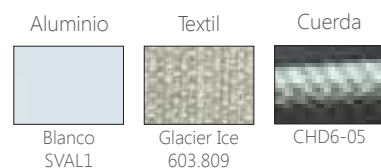

Ptos (pt)
736

Ref.(code)
30201005

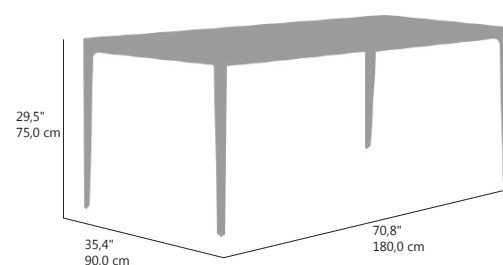

MESA DE COMEDOR MODELO TANGO RECTANGULAR
ESTRUCTURA EN ALUMINIO COLOR BLANCO
ENCIMERA BLANCA DE PIEDRA SINTERIZADA DE 12 MM
ALTA RESISTENCIA A LA INTemperIE.
REQUIERE MONTAJE.

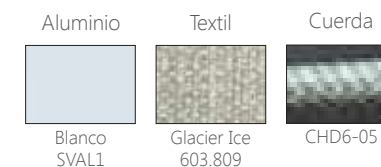

180*90*75cm

Ref.(code)
30201006

Ptos (pt)
905

240*90*75cm

Ref.(code)
30201011

Ptos (pt)
1386

MESA DE COMEDOR MODELO TANGO REDONDA
 ESTRUCTURA EN ALUMINIO COLOR BLANCO
 ENCIMERA BLANCA DE PIEDRA SINTERIZADA DE 12 MM
 ALTA RESISTENCIA A LA INTEMPERIE
 REQUIERE MONTAJE

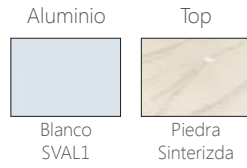
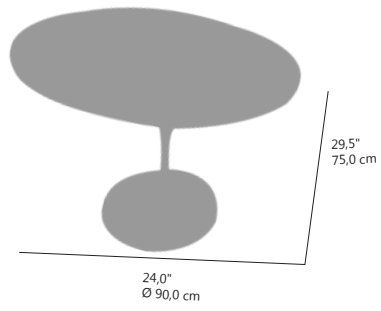

Ptos (pt)
657

Ref.(code)
30201007

39.3"
100,0 cm

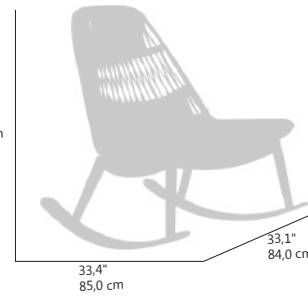

BALANCÍN/SILLÓN RELAX
 ESTRUCTURA DE ALUMINIO COLOR BLANCO
 COJÍN DE ASIENTO (5 CM) Y RESPALDO (5 CM)
 TEXTIL OLIFINE JASPEADO
 CUERDA REDONDA TRENZADA DE ALTA CALIDAD
 NO APILABLE
 REQUIERE MONTAJE

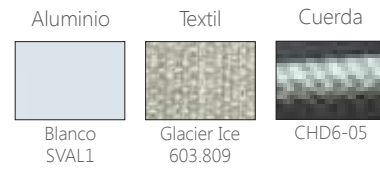

Ptos (pt)
708

Ref.(code)
30201010



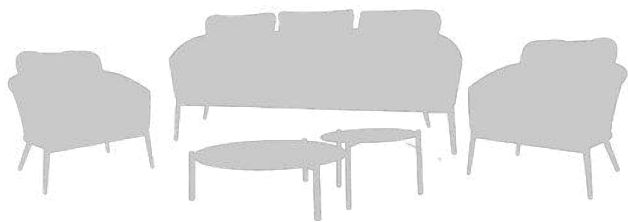

SET DE SOFÁ MODELO SOBER
 ESTRUCTURA EN ALUMINIO COLOR ANTRACITA
 COJÍN DE ASIENTO (12 CM) Y RESPALDO (12 CM)
 TEXTIL OLIFINE JASPEADO
 CUERDA REDONDA TRENZADA DE ALTA CALIDAD
 MESA REDONDA AUXILIAR ALUMINIO COLOR ANTRACITA

Ptos (pt)
2982

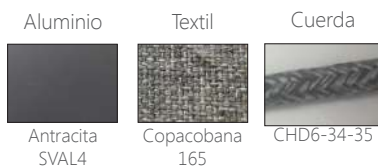

Ref.(code)
30201040

32,3"
82,0 cm



32,3"
82,0 cm

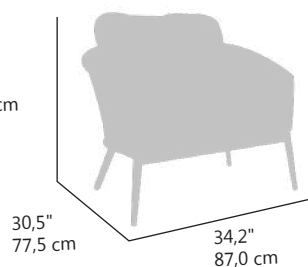

11,2"
28,5 cm

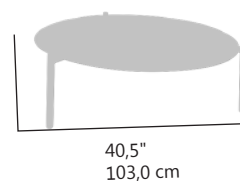

14,7"
37,5 cm

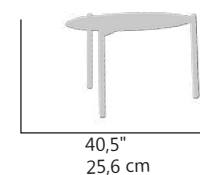

SILLA DE COMEDOR MODELO SOBER
 ESTRUCTURA DE ALUMINIO COLOR ANTRACITA
 COJÍN DE ASIENTO (5 CM) Y RESPALDO (5 CM)
 TEXTIL OLIFINE JASPEADO
 CUERDA REDONDA TRENZADA
 DE ALTA CALIDAD
 APILABLE

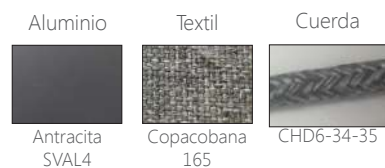
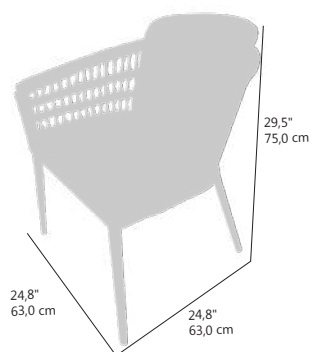

Ptos (pt)
395

Ref.(code)
30201045

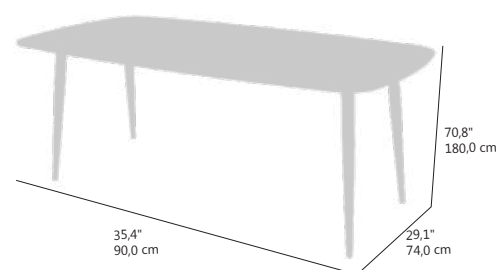

MESA DE COMEDOR SOBER
 ESTRUCTURA EN ALUMINIO COLOR ANTRACITA
 ENCIMERA ANTRACITA DE PIEDRA SINTERIZADA DE 12 MM
 ALTA RESISTENCIA A LA INTEMPERIE
 REQUIERE MONTAJE

Ptos (pt)
977



Ref.(code)
30201007





Silla de comedor con brazos Isabelle. Estructura en aluminio color blanco y textilene de doble pared con **Quick dry foam** color gris claro. Alta resistencia a la intemperie. Apilable.



AA(cm)	SH(IN)	AB(cm)	AH(IN)	AE(cm)	FH(IN)
42,0	16,5	64,0	25,2	90	35,4
PN(kg)	NW(LB)	REF.(CODE)	PTOS (PT)		
4,0	8,8	30200683	188		



Silla de comedor con brazos Isabelle. Estructura en aluminio color taupe y textilene de doble pared con **Quick dry foam** color taupe. Alta resistencia a la intemperie. Apilable.



AA(cm)	SH(IN)	AB(cm)	AH(IN)	AE(cm)	FH(IN)
42,0	16,5	64,0	25,2	90	35,4
PN(kg)	NW(LB)	REF.(CODE)	PTOS (PT)		
4,0	8,8	30200684	188		



Taburete alto con brazos Isabelle. Estructura en aluminio color blanco y textilene de doble pared con **Quick dry foam** color gris claro. Alta resistencia a la intemperie. Apilable.



AA(cm)	SH(IN)	AB(cm)	AH(IN)	AE(cm)	FH(IN)
70,5	27,8	91,8	36,1	112	44,1
PN(kg)	NW(LB)	REF.(CODE)	PTOS (PT)		
5,1	11,2	30200689	196		



Taburete alto con brazos Isabelle. Estructura en aluminio color taupe y textilene de doble pared con **Quick dry foam** color taupe. Alta resistencia a la intemperie. Apilable.

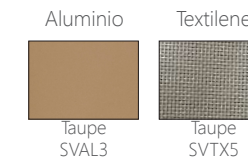

AA(cm)	SH(IN)	AB(cm)	AH(IN)	AE(cm)	FH(IN)
70,5	27,8	91,8	36,1	112	44,1
PN(kg)	NW(LB)	REF.(CODE)	PTOS (PT)		
5,1	11,2	30200690	196		

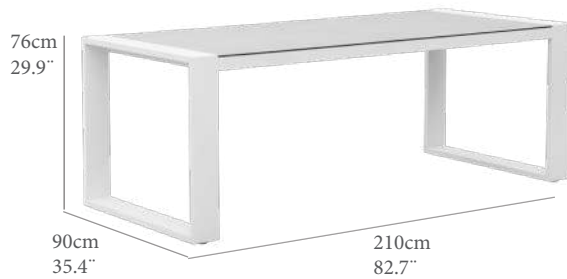

Mesa de comedor rectangular Isabelle. Estructura de aluminio color blanco. Encimera en cristal cerámico de alta durabilidad con acabado "Sky grey". Requiere montaje.



GT(cm)	TT(IN)	AL(cm)	FH(IN)
0,8	0,3	71,0	28
PN(kg)	NW(LB)	REF.(CODE)	PTOS (PT)
51,0	112,4	30200680	1258



Mesa de comedor rectangular Isabelle. Estructura de aluminio color taupe. Encimera en cristal cerámico de alta durabilidad con acabado "Galaxy granit". Requiere montaje.

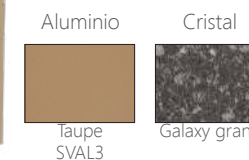

GT(cm)	TT(IN)	AL(cm)	FH(IN)
0,8	0,3	71,0	28
PN(kg)	NW(LB)	REF.(CODE)	PTOS (PT)
51,0	112,4	30200681	1258



Mesa alta rectangular Isabelle. Estructura de aluminio color blanco y top de aluminio color blanco. Requiere montaje.



GT(cm)	TT(IN)	AL(cm)	FH(IN)
4,0	1,6	102	40,2
PN(kg)	NW(LB)	REF.(CODE)	PTOS (PT)
49,8	109,8	30200693	676



Mesa alta rectangular Isabelle. Estructura de aluminio color taupe y top de aluminio color taupe. Requiere montaje.

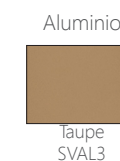

GT(cm)	TT(IN)	AL(cm)	FH(IN)
4,0	1,6	102	40,2
PN(kg)	NW(LB)	REF.(CODE)	PTOS (PT)
49,8	109,8	30200694	676



Sofá de 1 plaza modelo Antares
Estructura en aluminio color Antracita. Cojín de asiento y respaldo color gris Tempo. Cojín de asiento de 15cm. Cojín de respaldo de 15cm. Waterproof.



AA(CM)	SH(IN)	AB(CM)	AH(IN)	AE(CM)	FH(IN)
33,5	13,2	54,0	21,3	54,0	21,3
PN(KG)	NW(LB)	REF.(CODE)	PTOS (PT)		
28,0	61,8	30200563	826		



Sofá de 3 plazas modelo Antares
Estructura en aluminio color Antracita. Cojín de asiento y respaldo color gris Tempo. Cojín de asiento de 15cm. Cojín de respaldo de 15cm. Waterproof.

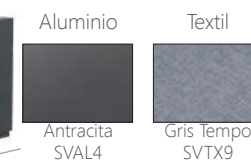

AA(CM)	SH(IN)	AB(CM)	AH(IN)	AE(CM)	FH(IN)
33,5	13,2	54,0	21,3	54,0	21,3
PN(KG)	NW(LB)	REF.(CODE)	PTOS (PT)		
54,2	119,7	30200564	1534		



Modulo 3 plazas brazo derecho Antares
Estructura en aluminio color Antracita. Cojín de asiento y respaldo color gris Tempo. Cojín de asiento de 15cm. Cojín de respaldo de 15cm. Waterproof.

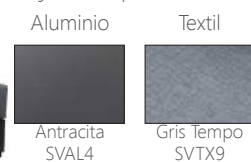

AA(CM)	SH(IN)	AB(CM)	AH(IN)	AE(CM)	FH(IN)
33,5	13,2	54,0	21,3	54,0	21,3
PN(KG)	NW(LB)	REF.(CODE)	PTOS (PT)		
48,3	106,6	30200567	1710		



Modulo 3 plazas brazo izquierdo Antares
Estructura en aluminio color Antracita. Cojín de asiento y respaldo color gris Tempo. Cojín de asiento de 15cm. Cojín de respaldo de 15cm. Waterproof.

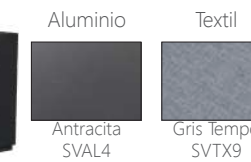

AA(CM)	SH(IN)	AB(CM)	AH(IN)	AE(CM)	FH(IN)
33,5	13,2	54,0	21,3	54,0	21,3
PN(KG)	NW(LB)	REF.(CODE)	PTOS (PT)		
48,3	106,6	30200566	1710		



Modulo lounge brazo izquierdo Antares
Estructura en aluminio color Antracita. Cojín de asiento y respaldo color gris Tempo. Cojín de asiento de 15cm. Cojín de respaldo de 15cm. Waterproof.



AA(CM)	SH(IN)	AB(CM)	AH(IN)	AE(CM)	FH(IN)
33,5	13,2	54,0	21,3	54,0	21,3
PN(KG)	NW(LB)	REF.(CODE)	PTOS (PT)		
50,3	111,1	30200568	1630		



Modulo lounge brazo derecho Antares
Estructura en aluminio color Antracita. Cojín de asiento y respaldo color gris Tempo. Cojín de asiento de 15cm. Cojín de respaldo de 15cm. Waterproof.

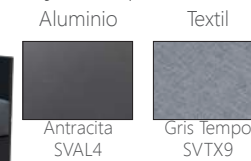

AA(CM)	SH(IN)	AB(CM)	AH(IN)	AE(CM)	FH(IN)
33,5	13,2	54,0	21,3	54,0	21,3
PN(KG)	NW(LB)	REF.(CODE)	PTOS (PT)		
50,3	111,1	30200569	1630		



Daybed modelo Antares.
Estructura en aluminio color Antracita.
Cojin de asiento y respaldo color gris Tempo. Cojin waterproof de 10cm.
Ruedas de transporte incluidas.



AA(cm)	SH(IN)	AR(cm)	BH(IN)	AB(cm)	AA(IN)
31,5	12,4	31/79	12,4/31,3		
PN(kg)	NW(Lb)	REF.(CODE)		PTOS (PT)	
31,4	69,3	30200571		1534	



Mesa Auxiliar modelo Antares.
Estructura de aluminio color antracita y top en lamas de aluminio color Antracita.



GT(cm)	TT(IN)	AL(cm)	FH(IN)	
0,3	0,1	27,5	10,8	
PN(kg)	NW(Lb)	REF.(CODE)		PTOS (PT)
13,9	30,7	30200565		448

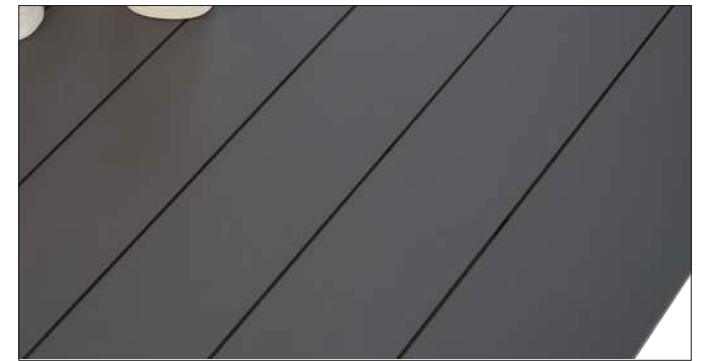





Tumbona de 1 plaza modelo New Oslo. Estructura en aluminio color blanco. Cojín de tumbona de 8cm de grosor color blanco. Con rueda oculta de transporte..
Aluminio Textil

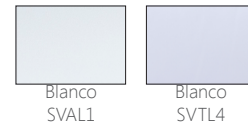

AA(cm)	SH(IN)	AR(cm)	BH(IN)	AB(cm)	AA(IN)
38,0	15,0	30/80	11,8/31,5		
PN(kg)	NW(LB)	REF.(CODE)	PTOS (PT)		
18,8	41,4	30200282	652		



Tumbona de 1 plaza modelo New Oslo. Estructura en aluminio color blanco. Cojín de tumbona de 8cm de grosor color gris claro. Con rueda oculta de transporte..
Aluminio Textil



AA(cm)	SH(IN)	AR(cm)	BH(IN)	AB(cm)	AA(IN)
38,0	15,0	30/80	11,8/31,5		
PN(kg)	NW(LB)	REF.(CODE)	PTOS (PT)		
18,8	41,4	30200283	652		



Daybed 2 plazas New Oslo. Estructura en aluminio color blanco. Cojinería de 10cm de grosor color blanco. Respaldos con regulación independiente.
Aluminio Textil

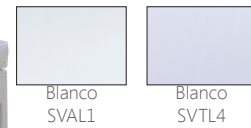

AA(cm)	SH(IN)	AR(cm)	BH(IN)	AB(cm)	AA(IN)
40,0	15,7	30/80	11,8/31,5		
PN(kg)	NW(LB)	REF.(CODE)	PTOS (PT)		
31,5	69,4	30200284	1298		



Daybed 2 plazas New Oslo. Estructura en aluminio color blanco. Cojinería de 10cm de grosor color gris. Respaldos con regulación independiente.
Aluminio Textil

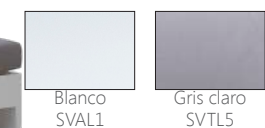

AA(cm)	SH(IN)	AR(cm)	BH(IN)	AB(cm)	AA(IN)
40,0	15,7	30/80	11,8/31,5		
PN(kg)	NW(LB)	REF.(CODE)	PTOS (PT)		
31,5	69,4	30200285	1298		

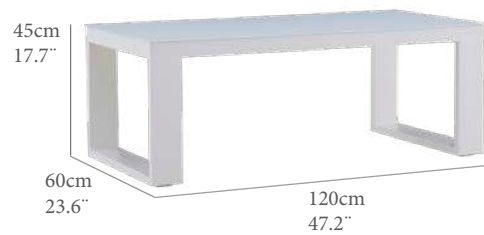

Mesa Auxiliar modelo New Oslo. Estructura de aluminio color blanco y encimera en cristal templado de 8mm color blanco mate.
Aluminio Cristal



GT(cm)	TT(IN)	AL(cm)	FH(IN)
0,5	0,2	40,0	15,7
PN(kg)	NW(LB)	REF.(CODE)	PTOS (PT)
13,7	30,2	39600105	326



Mesa lateral para tumbona o Daybed modelo New Oslo. Estructura de aluminio color blanco. Encimera en aluminio color blanco.
Aluminio





GT(cm)	TT(IN)	AL(cm)	FH(IN)
0,5	0,2	49,5	19,5
PN(kg)	NW(LB)	REF.(CODE)	PTOS (PT)
6,0	13,2	30200286	160

Sofá de 1 plaza modelo Hadar. Estructura en aluminio greige y cuerda gris claro.Revestimiento en textil gris claro. Alta resistencia a la intemperie.

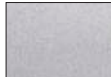

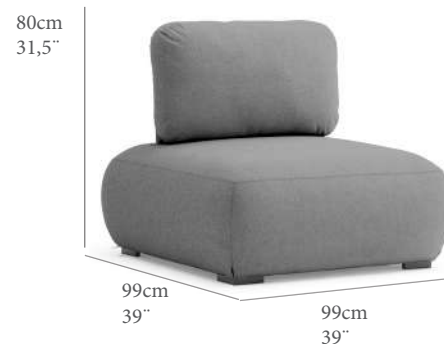

Estructura		Textil			
					
Gris S,light SVAL8		Gris claro SVTL22			
AA(cm)	SH(IN)	AB(cm)	AH(IN)	AE(cm)	FH(IN)
43	16.9			77	30.3
PN(kg)	NW(LB)	REF.(CODE)	PTOS (PT)		
18.7	41.2	30200830	842		





Estructura		Textil			
					
Antracita SVAL4		Gris flurotita SVTL30			
AA(cm)	SH(IN)	AB(cm)	AH(IN)	AE(cm)	FH(IN)
43	16.9			77	30.3
PN(kg)	NW(LB)	REF.(CODE)	PTOS (PT)		
18.7	41.2	30200835	842		

Sofá esquinero modelo Hadar. Estructura en aluminio greige y cuerda gris claro.Revestimiento en textil gris claro. Alta resistencia a la intemperie.





Estructura		Textil			
					
Gris S,light SVAL8		Gris claro SVTL22			
AA(cm)	SH(IN)	AB(cm)	AH(IN)	AE(cm)	FH(IN)
43	16.9			77	30.3
PN(kg)	NW(LB)	REF.(CODE)	PTOS (PT)		
31.8	70.1	30200831	1520		



Estructura		Textil			
					
Antracita SVAL4		Gris flurotita SVTL30			
AA(cm)	SH(IN)	AB(cm)	AH(IN)	AE(cm)	FH(IN)
43	16.9			77	30.3
PN(kg)	NW(LB)	REF.(CODE)	PTOS (PT)		
31.8	70.1	30200836	1520		

Sofá dos plazas modelo Hadar. Estructura en aluminio greige y cuerda gris claro.Revestimiento en textil gris claro. Alta resistencia a la intemperie.

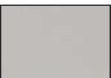

Estructura		Textil			
					
Gris S,light SVAL8		Gris claro SVTL22			
AA(cm)	SH(IN)	AB(cm)	AH(IN)	AE(cm)	FH(IN)
43	16.9			77	30.3
PN(kg)	NW(LB)	REF.(CODE)	PTOS (PT)		
36	79.3	30200834	1540		

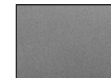

Estructura		Textil			
					
Antracita SVAL4		Gris flurotita SVTL30			
AA(cm)	SH(IN)	AB(cm)	AH(IN)	AE(cm)	FH(IN)
43	16.9			77	30.3
PN(kg)	NW(LB)	REF.(CODE)	PTOS (PT)		
36	79.3	30200839	1540		

Puff con mesa auxiliar modelo Hadar. Estructura en aluminio greige y cuerda gris claro.Revestimiento en textil gris claro. Alta resistencia a la intemperie.



Estructura		Textil			
					
Gris S,light SVAL8		Gris claro SVTL22			
AA(cm)	SH(IN)	AB(cm)	AH(IN)	AE(cm)	FH(IN)
43	16.9			43	16.9
PN(kg)	NW(LB)	REF.(CODE)	PTOS (PT)		
18.3	40.3	30200833	884		



Puff con mesa auxiliar modelo Hadar. Estructura en aluminio antracita y cuerda antracita. Revestimiento en textil antracita. Alta resistencia a la intemperie.

Estructura		Textil			
					
Antracita SVAL4		Gris flurotita SVTL30			
AA(cm)	SH(IN)	AB(cm)	AH(IN)	AE(cm)	FH(IN)
43	16.9			43	16.9
PN(kg)	NW(LB)	REF.(CODE)	PTOS (PT)		
18.3	40.3	30200838	884		



Tumbona lounge modelo Hadar. Estructura en aluminio greige y cuerda gris claro.Revestimiento en textil gris claro. Alta resistencia a la intemperie.

Estructura Textil

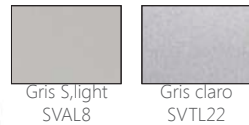

AA(cm)	SH(IN)	AB(cm)	AH(IN)	AE(cm)	FH(IN)
43	16.9			77	30.3
PN(kg)	NW(LB)	REF.(CODE)		PTOS (PT)	
26.9	59.3	30200832		1168	



Tumbona lounge modelo Hadar. Estructura en aluminio antracita y cuerda gris antracita.Revestimiento en textil antracita Alta resistencia a la intemperie.

Estructura Textil



AA(cm)	SH(IN)	AB(cm)	AH(IN)	AE(cm)	FH(IN)
43	16.9			77	30.3
PN(kg)	NW(LB)	REF.(CODE)		PTOS (PT)	
26.9	59.3	30200837		1168	



Mesa auxiliar redonda.Estructura de Aluminio color antracita.. Top en aluminio laminado 5mm gris. Alta resistencia a la intemperie.

Estructura



GT(cm)	TT(IN)	AL(cm)	FH(IN)	
0,3	0,1	45,0	17,7	
PN(kg)	NW(LB)	REF.(CODE)		PTOS (PT)
3,9	8,6	30200840		220



Mesa auxiliar redonda.Estructura de Aluminio color antracita.. Top en aluminio laminado 5mm gris. Alta resistencia a la intemperie.

Estructura



GT(cm)	TT(IN)	AL(cm)	FH(IN)	
0,3	0,1	40,0	15,7	
PN(kg)	NW(LB)	REF.(CODE)		PTOS (PT)
5,0	11,0	30200841		264



Mesa auxiliar redonda.Estructura de Aluminio color gris claro. Top en aluminio laminado 5mm gris. Alta resistencia a la intemperie.

Estructura



GT(cm)	TT(IN)	AL(cm)	FH(IN)	
0,3	0,1	45,0	17,7	
PN(kg)	NW(LB)	REF.(CODE)		PTOS (PT)
3,9	8,6	30200633		220



Mesa auxiliar redonda.Estructura de Aluminio color gris claro. Top en aluminio laminado 5mm gris. Alta resistencia a la intemperie.

Estructura



GT(cm)	TT(IN)	AL(cm)	FH(IN)	
0,3	0,1	40,0	15,7	
PN(kg)	NW(LB)	REF.(CODE)		PTOS (PT)
5,0	11,0	30200634		264



Silla de comedor modelo Viken. Estructura de aluminio color blanco y cuerda elastica en Olefina color gris claro. Cojin de asiento de 5cm color gris claro.



AA(cm)	SH(IN)	AB(cm)	AH(IN)	AE(cm)	FH(IN)
47,0	18,5	64,5	25,4	81,0	31,9
PN(kg)	NW(Lb)	REF.(CODE)	PTOS (PT)		
5,7	12,5	30200558	306		



Silla de comedor modelo Viken. Estructura de aluminio color antracita y cuerda elastica en Olefina color antracita. Cojin de asiento de 5cm color gris Tempo.



AA(cm)	SH(IN)	AB(cm)	AH(IN)	AE(cm)	FH(IN)
47,0	18,5	64,5	25,4	81,0	31,9
PN(kg)	NW(Lb)	REF.(CODE)	PTOS (PT)		
5,7	12,5	30200560	306		





Mesa rectangular modelo Vken.
Estructura de aluminio color Arce y top en laminas de aluminio color Arce.
Requiere montaje.

Aluminio

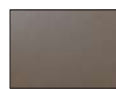

Arce
SVAL2

GT(cm)	TT(IN)	AL(cm)	FH(IN)
0,3	0,1	71,0	28,0
PN(kg)	NW(LB)	REF.(CODE)	PTOS (PT)
15,7	34,7	30200418	760



Mesa rectangular modelo Vken.
Estructura de aluminio color Antracita y top en laminas de aluminio color Antracita.
Requiere montaje.

Aluminio



Antracita
SVAL4

GT(cm)	TT(IN)	AL(cm)	FH(IN)
0,3	0,1	71,0	28,0
PN(kg)	NW(LB)	REF.(CODE)	PTOS (PT)
15,7	34,7	30200419	760

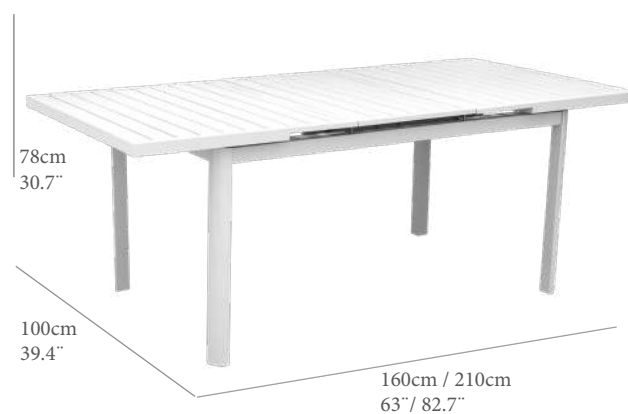

Mesa rectangular extensible modelo Vken.
Estructura de aluminio color blanco y top en laminas de aluminio color blanco.
Requiere montaje.

Aluminio

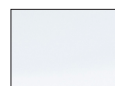

Blanco
SVAL1

GT(cm)	TT(IN)	AL(cm)	FH(IN)
0,3	0,1	70,5	27,8
PN(kg)	NW(LB)	REF.(CODE)	PTOS (PT)
27,8	61,4	30200414	1168

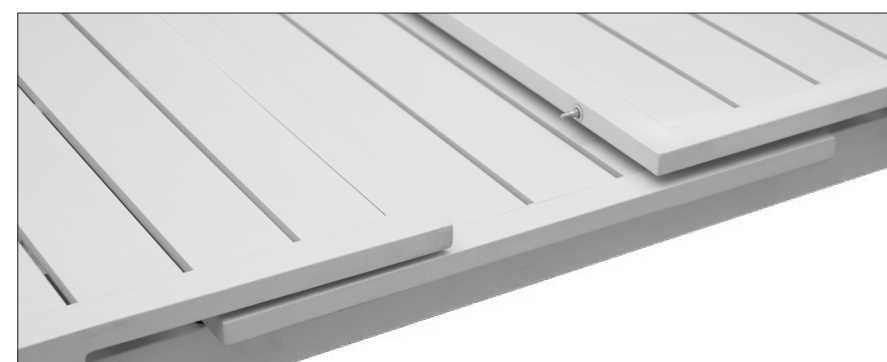



Sofa 1 plaza modelo Viken. Estructura de aluminio color blanco y cuerda elastica en Olefina color gris claro. Cojin de asiento y respaldo (10cm) color gris claro.



AA(cm)	SH(IN)	AB(cm)	AH(IN)	AE(cm)	FH(IN)
40,0	15,7	66,0	25,9	72	28,3
PN(kg)	NW(LB)	REF.(CODE)	PTOS (PT)		
11,7	25,8	30200670	782		



Sofa 3 plazas modelo Viken. Estructura de aluminio color blanco y cuerda elastica en Olefina color gris claro. Cojin de asiento y respaldo (10cm) color gris claro.



AA(cm)	SH(IN)	AB(cm)	AH(IN)	AE(cm)	FH(IN)
40,0	15,7	66,0	25,9	72	28,3
PN(kg)	NW(LB)	REF.(CODE)	PTOS (PT)		
29,5	65,0	30200671	1744		



Sofa 1 plaza modelo Viken. Estructura de aluminio color antracita y cuerda elastica en Olefina color antracita. Cojin de asiento y respaldo (10cm) color gris Tempo.



AA(cm)	SH(IN)	AB(cm)	AH(IN)	AE(cm)	FH(IN)
40,0	15,7	66,0	25,9	72	28,3
PN(kg)	NW(LB)	REF.(CODE)	PTOS (PT)		
11,7	25,8	30200674	782		



Sofa 3 plazas modelo Viken. Estructura de aluminio color antracita y cuerda elastica en Olefina color antracita. Cojin de asiento y respaldo (10cm) color gris Tempo.



AA(cm)	SH(IN)	AB(cm)	AH(IN)	AE(cm)	FH(IN)
40,0	15,7	66,0	25,9	72	28,3
PN(kg)	NW(LB)	REF.(CODE)	PTOS (PT)		
29,5	65,0	30200675	1744		



Mesa auxiliar modelo Viken. Estructura de aluminio color blanco y top de aluminio color blanco. Requiere montaje.



GT(cm)	TT(IN)	AL(cm)	FH(IN)
0,5	0,2	35,0	13,8
PN(kg)	NW(LB)	REF.(CODE)	PTOS (PT)
9,0	17,6	30200676	372

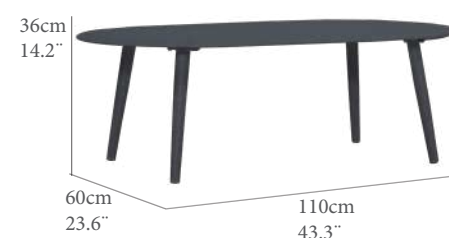

Mesa auxiliar modelo Viken. Estructura de aluminio color antracita y top de aluminio color antracita. Requiere montaje.



GT(cm)	TT(IN)	AL(cm)	FH(IN)
0,5	0,2	35,0	13,8
PN(kg)	NW(LB)	REF.(CODE)	PTOS (PT)
9,0	17,6	30200677	372



Taburete alto modelo Viken. Estructura de aluminio color blanco y cuerda elastica en Olefina color gris claro. Cojin de asiento (5cm) color gris claro.

Aluminio	Cuerda	Textil			
Blanco SVAL1	Gris claro SVC R1	Gris claro SVTL5			
AA(cm)	SH(IN)	AB(cm)	AH(IN)	AE(cm)	FH(IN)
40,0	15,7	66,0	25,9	72	28,3
PN(kg)	NW(LB)	REF.(CODE)	PTOS (PT)		
11,7	25,8	30200660	358		



Taburete alto modelo Viken. Estructura de aluminio color blanco y cuerda elastica en Olefina color Taupe. Cojin de asiento (5cm) color Taupe.

Aluminio	Cuerda	Textil			
Blanco SVAL1	Taupe SVC R2	Taupe SVTL7			
AA(cm)	SH(IN)	AB(cm)	AH(IN)	AE(cm)	FH(IN)
40,0	15,7	66,0	25,9	72	28,3
PN(kg)	NW(LB)	REF.(CODE)	PTOS (PT)		
11,7	25,8	30200661	358		



Taburete alto modelo Viken. Estructura de aluminio color antracita y cuerda elastica en Olefina color antracita. Cojin de asiento (5cm) color gris Tempo.

Aluminio	Cuerda	Textil			
Antracita SVAL4	Antracita SVC R3	Gris Tempo SVTX9			
AA(cm)	SH(IN)	AB(cm)	AH(IN)	AE(cm)	FH(IN)
40,0	15,7	66,0	25,9	72	28,3
PN(kg)	NW(LB)	REF.(CODE)	PTOS (PT)		
11,7	25,8	30200662	358		



Mesa bar rectangular blanca. Estructura de aluminio color blanco y top de aluminio color blanco. Requiere montaje.

Aluminio					
Blanco SVAL1					
GT(cm)	TT(IN)	AL(cm)	FH(IN)		
4,0	1,6	102	40,2		
PN(kg)	NW(LB)	REF.(CODE)	PTOS (PT)		
49,8	109,8	30200693	676		





Daybed modelo Viken. Estructura de aluminio color blanco y cuerda elastica en Olefina color gris claro. Colchon de 10cm color gris claro. Respaldo regulable en altura.



AA(cm)	SH(IN)	AR(cm)	BH(IN)	AE(cm)	FH(IN)
39,0	15.3	40/82	15.7/32.2	54	21.2
PN(kg)	NW(LB)	REF.(CODE)	PTOS (PT)		
49	108	30200665	2700		



Daybed modelo Viken. Estructura de aluminio color blanco y cuerda elastica en Olefina color Taupe. Colchon de 10cm color Taupe. Respaldo regulable en altura.



AA(cm)	SH(IN)	AR(cm)	BH(IN)	AE(cm)	FH(IN)
39,0	15.3	40/82	15.7/32.2	54	21.2
PN(kg)	NW(LB)	REF.(CODE)	PTOS (PT)		
49	108	30200666	2700		



Daybed modelo Viken. Estructura de aluminio color antracita y cuerda elastica en Olefina color antracita. Colchon de 10cm color gris Tempo. Respaldo regulable en altura.



AA(cm)	SH(IN)	AR(cm)	BH(IN)	AE(cm)	FH(IN)
39,0	15.3	40/82	15.7/32.2	54	21.2
PN(kg)	NW(LB)	REF.(CODE)	PTOS (PT)		
49	108	30200667	2700		

83cm
32.7"



65cm
25.5"

57cm
22.4"

Silla de comedor Vega. Estructura de aluminio color blanco y cuerda elastica en Olefina color gris claro. Cojín de asiento (5cm) color gris claro.



AA(CM)	SH(IN)	AB(CM)	AH(IN)	AE(CM)	FH(IN)
44.5	17.5	67	26.3	83	32.7
PN(KG)	NW(LB)	REF.(CODE)	PTOS (PT)		
4.4	9.7	30200657	168		



Silla de comedor Vega. Estructura de aluminio color antracita y cuerda elastica en Olefina color antracita. Cojín de asiento (5cm) color gris Tempo.

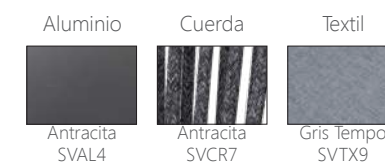

AA(CM)	SH(IN)	AB(CM)	AH(IN)	AE(CM)	FH(IN)
44.5	17.5	67	26.3	83	32.7
PN(KG)	NW(LB)	REF.(CODE)	PTOS (PT)		
4.4	9.7	30200659	168		





Sofá 1 plaza modelo Deneb. Estructura de Aluminio color Antracita. Trenzado en cuerda sintética 40x1.5mm color Antracita. Cojinería asiento 29cm (Respaldo 12cm) color gris medio. Alta resistencia a la intemperie.



AA(cm)	SH(IN)	AB(cm)	AH(IN)	AE(cm)	FH(IN)
40,0	15,7	67,0	26,4	67,0	26,4
PN(kg)	NW(LB)	REF.(CODE)	PTOS (PT)		
22,0	48,5	30200638	1162		



Lateral brazo izquierdo modelo Deneb. Estructura de Aluminio color Antracita. Trenzado en cuerda sintética 40x1.5mm color Antracita. Cojinería asiento 29cm (Respaldo 12cm) color gris medio. Alta resistencia a la intemperie.



AA(cm)	SH(IN)	AB(cm)	AH(IN)	AE(cm)	FH(IN)
40,0	15,7	67,0	26,4	67,0	26,4
PN(kg)	NW(LB)	REF.(CODE)	PTOS (PT)		
21,0	46,3	30200639	1231		



Lateral brazo derecho modelo Deneb. Estructura de Aluminio color Antracita. Trenzado en cuerda sintética 40x1.5mm color Antracita. Cojinería asiento 29cm (Respaldo 12cm) color gris medio. Alta resistencia a la intemperie.



AA(cm)	SH(IN)	AB(cm)	AH(IN)	AE(cm)	FH(IN)
40,0	15,7	67,0	26,4	67,0	26,4
PN(kg)	NW(LB)	REF.(CODE)	PTOS (PT)		
21,0	46,3	30200640	1231		



Modulo de ampliación modelo Deneb. Estructura de Aluminio color Antracita. Trenzado en cuerda sintética 40x1.5mm color Antracita. Cojinería asiento 29cm (Respaldo 12cm) color gris medio. Alta resistencia a la intemperie.



AA(cm)	SH(IN)	AB(cm)	AH(IN)	AE(cm)	FH(IN)
40,0	15,7	67,0	26,4	67,0	26,4
PN(kg)	NW(LB)	REF.(CODE)	PTOS (PT)		
14,2	31,3	30200641	707		



Puff reposapiés modelo Deneb. Estructura de Aluminio color Antracita. Trenzado en cuerda sintética 40x1.5mm color Antracita. Cojinería asiento 29cm color gris medio. Alta resistencia a la intemperie.



AA(cm)	SH(IN)	AB(cm)	AH(IN)	AE(cm)	FH(IN)
40,0	15,7			40,0	15,7
PN(kg)	NW(LB)	REF.(CODE)	PTOS (PT)		
11,5	25,4	30200642	672		



Mesa auxiliar modelo Deneb. Estructura de Aluminio color Antracita. Trenzado en cuerda sintética 40x1.5mm color Antracita. Top en cristal cerámico 5mm gris. Alta resistencia a la intemperie.



GT(cm)	TT(IN)	AL(cm)	FH(IN)
0,5	0,2	38,0	15,0
PN(kg)	NW(LB)	REF.(CODE)	PTOS (PT)
22,5	49,6	30200637	526



Reposapiés doble modelo Deneb. Estructura de Aluminio color Antracita. Trenzado en cuerda sintética 40x1.5mm color Antracita. Cojinería asiento 29cm color gris medio. Alta resistencia a la intemperie.



AA(cm)	SH(IN)	AB(cm)	AH(IN)	AE(cm)	FH(IN)
40,0	15,7			40,0	15,7
PN(kg)	NW(LB)	REF.(CODE)	PTOS (PT)		
8,8	19,4	30200655	510		



Sillón de comedor Deneb. Estructura de Aluminio color Antracita. Trenzado en cuerda sintética 40x1.5mm color Antracita. Cojinería asiento y respaldo 5cm color gris medio. Alta resistencia a la intemperie.



AA(cm)	SH(IN)	AB(cm)	AH(IN)	AE(cm)	FH(IN)
42.0	16.5	61	24	80	31.5
PN(kg)	NW(LB)	REF.(CODE)	PTOS (PT)		
6.4	14.1	30200651	400		



Mesa de comedor modelo Deneb. Estructura de Aluminio color Antracita. top en cristal cerámico 8mm gris. Alta resistencia a la intemperie.



GT(cm)	TT(IN)	AL(cm)	FH(IN)
0,8	0,3	69,0	27,1
PN(kg)	NW(LB)	REF.(CODE)	PTOS (PT)
26.0	10.2	30200652	592



Tumbona modelo Deneb. Estructura de Aluminio color Antracita. Trenzado en cuerda sintética 40x1.5mm color Antracita. Cojinería asiento 29cm color gris medio. Alta resistencia a la intemperie.



AA(cm)	SH(IN)	AR(cm)	BH(IN)	AB(cm)	AA(IN)
40,0	15,7	40/102	15,7/40,1		
PN(kg)	NW(LB)	REF.(CODE)	PTOS (PT)		
31,0	68,3	30200643	1448		





Modulo curvo brazo derecho Deneb. Estructura de Aluminio color Antracita. Trenzado en cuerda sintética 40x15mm color Antracita. Cojineria asiento 29cm (Respaldo 12cm) color gris medio. Alta resistencia a la intemperie.

Aluminio Cuerda Textil



AA(cm)	SH(IN)	AB(cm)	AH(IN)	AE(cm)	FH(IN)
40,0	15,7	67,0	26,4	67,0	26,4
PN(kg)	NW(LB)	REF.(CODE)	PTOS (PT)		
26,5	58,4	30200646	1478		



Modulo curvo brazo izquierdo Deneb. Estructura de Aluminio color Antracita. Trenzado en cuerda sintética 40x15mm color Antracita. Cojineria asiento 29cm (Respaldo 12cm) color gris medio. Alta resistencia a la intemperie.

Aluminio Cuerda Textil



AA(cm)	SH(IN)	AB(cm)	AH(IN)	AE(cm)	FH(IN)
40,0	15,7	67,0	26,4	67,0	26,4
PN(kg)	NW(LB)	REF.(CODE)	PTOS (PT)		
26,5	58,4	30200645	1478		



Modulo curvo Deneb. Estructura de Aluminio color Antracita. Trenzado en cuerda sintética 40x15mm color Antracita. Cojineria asiento 29cm (Respaldo 12cm) color gris medio. Alta resistencia a la intemperie.

Aluminio Cuerda Textil



AA(cm)	SH(IN)	AB(cm)	AH(IN)	AE(cm)	FH(IN)
40,0	15,7	67,0	26,4	67,0	26,4
PN(kg)	NW(LB)	REF.(CODE)	PTOS (PT)		
29,0	63,9	30200647	2732		

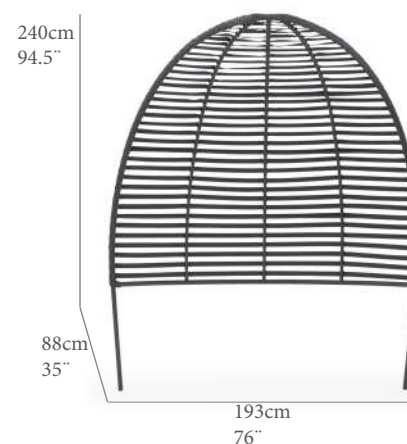

Cubierta solar para modulo curvo Deneb. Estructura de Aluminio color Antracita. Trenzado en cuerda sintética 40x15mm color Antracita. Alta resistencia a la intemperie.

Aluminio Cuerda

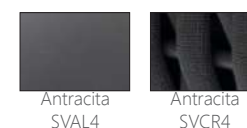

PN(kg)	NW(LB)	REF.(CODE)	PTOS (PT)	
14,5	32	30200648	1102	



Mesa redonda auxiliar Deneb. Estructura de Aluminio color Antracita. Trenzado en cuerda sintética 40x15mm color Antracita. Top en HPL 10mm gris. Alta resistencia a la intemperie.

Aluminio Cuerda Top



GT(cm)	TT(IN)	AL(cm)	FH(IN)
1	0,4	65,0	25,6
PN(kg)	NW(LB)	REF.(CODE)	PTOS (PT)
17,1	37,7	30200649	944



Mesa auxiliar modelo Deneb. Estructura de Aluminio color Antracita. Trenzado en cuerda sintética 40x1.5mm color Antracita. Top en cristal cerámico 8mm gris. Alta resistencia a la intemperie.

Aluminio Cuerda Cristal



GT(cm)	TT(IN)	AL(cm)	FH(IN)
0,8	0,3	50,0	19,7
PN(kg)	NW(LB)	REF.(CODE)	PTOS (PT)
17	21,4	30200644	668



Sofá 1 plaza modelo Borgen. Estructura de Aluminio color gris claro. Trenzado en cuerda sintética 6mm color gris claro. Cojinería asiento 15cm (Respaldo 12cm) color gris claro. Alta resistencia a la intemperie.



AA(cm)	SH(IN)	AB(cm)	AH(IN)	AE(cm)	FH(IN)
41,0	16,1	54,0	21,3	75,0	29,5
PN(kg)	NW(LB)	REF.(CODE)	PTOS (PT)		
13,5	29,8	30200630	944		



Sofá 2 plazas modelo Borgen. Estructura de Aluminio color gris claro. Trenzado en cuerda sintética 6mm color gris claro. Cojinería asiento 15cm (Respaldo 12cm) color gris claro. Alta resistencia a la intemperie.



AA(cm)	SH(IN)	AB(cm)	AH(IN)	AE(cm)	FH(IN)
41,0	16,1	54,0	21,3	75,0	29,5
PN(kg)	NW(LB)	REF.(CODE)	PTOS (PT)		
29,0	63,9	30200631	1674		



Reposapiés modelo Borgen. Estructura de Aluminio color gris claro. Trenzado en cuerda sintética 6mm color gris claro. Cojinería asiento 15cm (Respaldo 12cm) color gris claro. Alta resistencia a la intemperie.

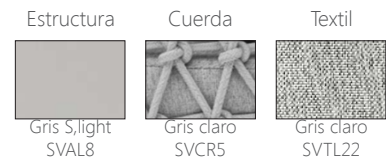

AA(cm)	SH(IN)	AB(cm)	AH(IN)	AE(cm)	FH(IN)
41,0	16,1			26,0	10,2
PN(kg)	NW(LB)	REF.(CODE)	PTOS (PT)		
4,1	9,0	30200632	300		



Reposapiés doble modelo Borgen. Estructura de Aluminio color gris claro. Trenzado en cuerda sintética 6mm color gris claro. Cojinería asiento 15cm (Respaldo 12cm) color gris claro. Alta resistencia a la intemperie.



AA(cm)	SH(IN)	AB(cm)	AH(IN)	AE(cm)	FH(IN)
41,0	16,1			26,0	10,2
PN(kg)	NW(LB)	REF.(CODE)	PTOS (PT)		
10,0	22,0	30200635	536		



Mesa auxiliar modelo Borgen. Estructura de Aluminio color gris claro. Top en aluminio laminado 5mm gris. Alta resistencia a la intemperie.



GT(cm)	TT(IN)	AL(cm)	FH(IN)
0,3	0,1	45,0	17,7
PN(kg)	NW(LB)	REF.(CODE)	PTOS (PT)
3,9	8,6	30200633	220



Mesa auxiliar modelo Borgen. Estructura de Aluminio color gris claro. Top en aluminio laminado 5mm gris. Alta resistencia a la intemperie.



GT(cm)	TT(IN)	AL(cm)	FH(IN)
0,3	0,1	40,0	15,7
PN(kg)	NW(LB)	REF.(CODE)	PTOS (PT)
5,0	11,0	30200634	264



Daybed modelo Borgen. Estructura de Aluminio color gris claro. Trenzado en cuerda sintética 6mm color gris claro. Cojinería asiento 15cm (Respaldo 12cm) color gris claro. Alta resistencia a la intemperie.



AA(cm)	SH(IN)	AR(cm)	BH(IN)	AB(cm)	AA(IN)
41,0	16,1	41/81	16,1/31,9	54,0	21,3
PN(kg)	NW(LB)	REF.(CODE)	PTOS (PT)		
38,9	85,8	30200636	2234		



Sillón de comedor modelo Long Island. Estructura en aluminio color Greige y cojinería acrílica (5cm) color gris Jaspeado. Revestimiento el cuerda trenzada de alta calidad.



AA(cm)	SH(IN)	AB(cm)	AH(IN)	AE(cm)	FH(IN)
47,0	18,5	65,0	25,6	87,0	34,3
PN(kg)	NW(LB)	REF.(CODE)	PTOS (PT)		
4,6	10,1	30200754	328		



Taburete alto modelo Long Island. Estructura en aluminio color Greige y cojinería acrílica (5cm) color gris Jaspeado. Revestimiento el cuerda trenzada de alta calidad.



AA(cm)	SH(IN)	AB(cm)	AH(IN)	AE(cm)	FH(IN)
73	28.7			103	40.5
PN(kg)	NW(LB)	REF.(CODE)	PTOS (PT)		
4,9	11.0	30200763	440		



Sofá de 2 plazas modelo Long Island. Estructura en aluminio color Greige, cojín de asiento (10cm) y respaldo (12cm) color gris Jaspeado. Revestimiento en cuerda trenzada alta calidad.



AA(cm)	SH(IN)	AB(cm)	AH(IN)	AE(cm)	FH(IN)
40,0	15,7	62,0	24,4	70,0	27,6
PN(kg)	NW(LB)	REF.(CODE)	PTOS (PT)		
30,0	66,1	30200751	2728		



Sofá de 1 plaza Long Island. Estructura en aluminio color Greige, cojín de asiento (10cm) y respaldo (12cm) color gris Jaspeado. Revestimiento en cuerda trenzada alta calidad.



AA(cm)	SH(IN)	AB(cm)	AH(IN)	AE(cm)	FH(IN)
40,0	15,7	62,0	24,4	70,0	27,6
PN(kg)	NW(LB)	REF.(CODE)	PTOS (PT)		
15,2	33,5	30200750	1370		



Mesa de comedor modelo Long island. Estructura en aluminio color Greige. Encimera en cristal templado de 8mm color Old marble.



GT(cm)	TT(IN)	AL(cm)	FH(IN)
0.8	0.3	89.0	35.0
PN(kg)	NW(LB)	REF.(CODE)	PTOS (PT)
23.7	52.2	30200766	1018



Mesa de comedor modelo Long island. Estructura en aluminio color Greige. Encimera en cristal templado de 8mm color Old marble.



GT(cm)	TT(IN)	AL(cm)	FH(IN)
0.8	0.3	89.0	35.0
PN(kg)	NW(LB)	REF.(CODE)	PTOS (PT)
23.7	52.2	30200765	896



Daybed modelo Long Island. Estructura en aluminio color Greige, cojín de asiento (10cm) y respaldo (12cm) color gris Jaspeado. Revestimiento en cuerda trenzada alta calidad.

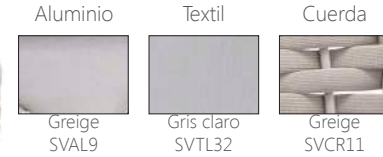

AA(cm)	SH(IN)	AR(cm)	BH(IN)	AB(cm)	AA(IN)
40,0	15,7	40/92	15,7/36,2		
PN(kg)	NW(LB)	REF.(CODE)	PTOS (PT)		
35,5	78,3	30200753	1948		



Tumbona modelo Long Island. Estructura en aluminio color Greige, cojín de asiento (10cm) y respaldo (12cm) color gris Jaspeado. Revestimiento en cuerda trenzada alta calidad.



AA(cm)	SH(IN)	AR(cm)	BH(IN)	AB(cm)	AA(IN)
40,0	15,7	40/92	15,7/36,2		
PN(kg)	NW(LB)	REF.(CODE)	PTOS (PT)		
18,6	41,0	30200752	1520		



Mesa auxiliar modelo Long Island. Estructura en aluminio color Greige y cristal templado de 8mm terminacion old marble. Revestimiento el cuerda trenzada de alta calidad.

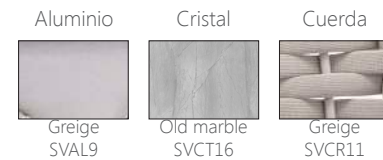

GT(cm)	TT(IN)	AL(cm)	FH(IN)
0,8	0,3	13,0	5,11
PN(kg)	NW(LB)	REF.(CODE)	PTOS (PT)
16,5	21,0	30200762	528





Silla de comedor modelo Nirea. Teca de primera calidad con herrajes en acero inoxidable. Requiere montaje.

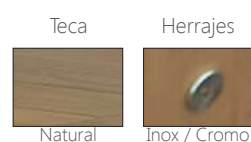

AA(cm)	SH(IN)	AB(cm)	AH(IN)	AE(cm)	FH(IN)
45,0	17,7			84,0	33,1
PN(kg)	NW(LB)	REF.(CODE)	PTOS (PT)		
9,5	20,9	30100172	190		



Sofa de 1 plaza modelo Nirea. Teca de primera calidad con herrajes en acero inoxidable. Cojinería de asiento (14cm) y respaldo (12cm) color blanco. Requiere montaje.



AA(cm)	SH(IN)	AB(cm)	AH(IN)	AE(cm)	FH(IN)
44,0	17,3	54,5	21,5	76,5	30,1
PN(kg)	NW(LB)	REF.(CODE)	PTOS (PT)		
25,5	56,2	30100167	606		



Sofa de 2 plazas modelo Nirea. Teca de primera calidad con herrajes en acero inoxidable. Cojinería de asiento (14cm) y respaldo (12cm) color blanco. Requiere montaje.

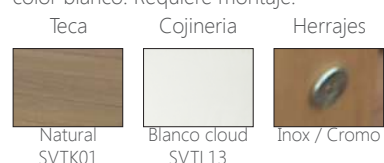

AA(cm)	SH(IN)	AB(cm)	AH(IN)	AE(cm)	FH(IN)
44,0	17,3	54,5	21,5	76,5	30,1
PN(kg)	NW(LB)	REF.(CODE)	PTOS (PT)		
39,0	86,0	30100170	1346		



Mesa de comedor cuadrada Nirea. Teca de primera calidad con herrajes en acero inoxidable. Requiere montaje.

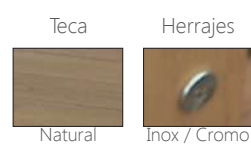

GT(cm)	TT(IN)	AL(cm)	FH(IN)
2,5	1,0	67,5	26,6
PN(kg)	NW(LB)	REF.(CODE)	PTOS (PT)
19,0	41,9	30100173	266



Mesa de comedor rectangular Nirea. Teca de primera calidad con herrajes en acero inoxidable. Requiere montaje.



GT(cm)	TT(IN)	AL(cm)	FH(IN)
2,5	1,0	67,5	26,6
PN(kg)	NW(LB)	REF.(CODE)	PTOS (PT)
37,0	81,6	30100174	506

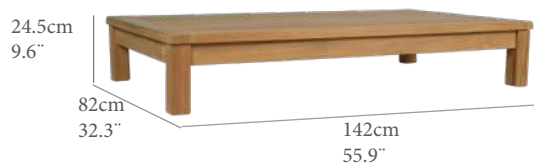

Mesa auxiliar Nirea. Teca de primera calidad con herrajes en acero inoxidable. Requiere montaje.

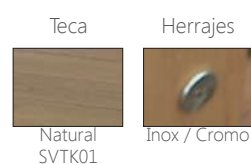

GT(cm)	TT(IN)	AL(cm)	FH(IN)
2,5	1,0	14,5	5,7
PN(kg)	NW(LB)	REF.(CODE)	PTOS (PT)
27,0	59,5	30100169	458



Daybed Nirea. Estructura en teca de primera calidad con herrajes en acero inoxidable. Cojinería waterproof (14cm) color crudo. Cubierta superior y cortinas incluidas. Requiere montaje.



AA(cm)	SH(IN)	AR(cm)	BH(IN)	AB(cm)	AA(IN)
46,0	18,1	33/100	13-39,4		
PN(kg)	NW(LB)	REF.(CODE)	PTOS (PT)		
163,0	359,4	30100175	3832		



Silla de comedor modelo Java. Estructura en teca de primera calidad. Herrajes en acabado inox. Requiere montaje.

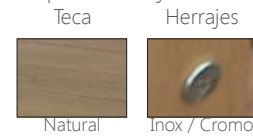

AA(cm)	SH(IN)	AB(cm)	AH(IN)	AE(cm)	FH(IN)
45,0	17,7			99,0	39,0
PN(kg)	NW(LB)	REF.(CODE)	PTOS (PT)		
11,0	24,3	30100138	230		



Silla de comedor con brazos modelo Java. Estructura en teca de primera calidad. Herrajes en acabado inox. Requiere montaje.

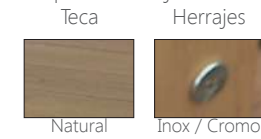

AA(cm)	SH(IN)	AB(cm)	AH(IN)	AE(cm)	FH(IN)
46,0	18,1	66,5	26,2	98,5	38,8
PN(kg)	NW(LB)	REF.(CODE)	PTOS (PT)		
10,0	22,0	30100171	242		

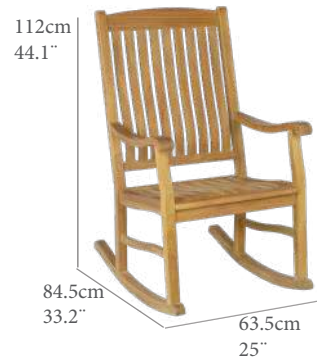

Butaca mecedora modelo Java. Estructura en teca de primera calidad. Herrajes en acabado inox. Requiere montaje.



AA(cm)	SH(IN)	AB(cm)	AH(IN)	AE(cm)	FH(IN)
47,0	18,5	73,0	28,7	112,0	44,1
PN(kg)	NW(LB)	REF.(CODE)	PTOS (PT)		
17,0	37,5	30100139	248		



Butaca 1 plaza modelo Java. Estructura en teca de primera calidad. Herrajes en acabado inox. Requiere montaje.

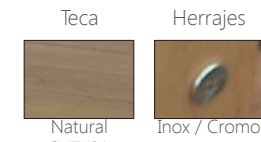

AA(cm)	SH(IN)	AB(cm)	AH(IN)	AE(cm)	FH(IN)
45,0	17,7	67,5	26,6	92,0	36,2
PN(kg)	NW(LB)	REF.(CODE)	PTOS (PT)		
13,0	28,7	30100093	214z		



Butaca 2 plazas modelo Java. Estructura en teca de primera calidad. Herrajes en acabado inox. Requiere montaje.



AA(cm)	SH(IN)	AB(cm)	AH(IN)	AE(cm)	FH(IN)
45,0	17,7	67,5	26,6	92,0	36,2
PN(kg)	NW(LB)	REF.(CODE)	PTOS (PT)		
21,0	46,3	30100094	324		



Butaca 3 plazas modelo Java. Estructura en teca de primera calidad. Herrajes en acabado inox. Requiere montaje.



AA(cm)	SH(IN)	AB(cm)	AH(IN)	AE(cm)	FH(IN)
45,0	17,7	67,5	26,6	92,0	36,2
PN(kg)	NW(LB)	REF.(CODE)	PTOS (PT)		
26,0	57,3	30100121	360zz		



Silla plegable modelo Edson. Estructura en teca de primera calidad y textilene **Batyline** color negro. Herrajes en acabado inox.

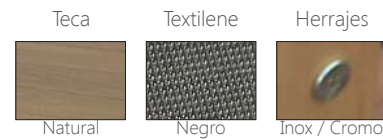

AA(cm)	SH(IN)	AB(cm)	AH(IN)	AE(cm)	FH(IN)
44,0	17,3	65,0	25,6	88,0	34,6
PN(kg)	NW(LB)	REF.(CODE)	PTOS (PT)		
8,0	17,6	30100146	336		



Silla plegable modelo Edson. Estructura en teca de primera calidad y textilene **Batyline** color blanco. Herrajes en acabado inox.



AA(cm)	SH(IN)	AB(cm)	AH(IN)	AE(cm)	FH(IN)
44,0	17,3	65,0	25,6	88,0	34,6
PN(kg)	NW(LB)	REF.(CODE)	PTOS (PT)		
8,0	17,6	30100160	336		



Silla de comedor modelo Edson. Estructura en teca de primera calidad y textilene **Batyline** color negro. Herrajes en acabado inox. Requiere montaje.



AA(cm)	SH(IN)	AB(cm)	AH(IN)	AE(cm)	FH(IN)
44,0	17,3	65,0	25,6	78,0	30,7
PN(kg)	NW(LB)	REF.(CODE)	PTOS (PT)		
8,0	17,6	30100147	342		



Silla de comedor modelo Edson. Estructura en teca de primera calidad y textilene **Batyline** color blanco. Herrajes en acabado inox. Requiere montaje.



AA(cm)	SH(IN)	AB(cm)	AH(IN)	AE(cm)	FH(IN)
44,0	17,3	65,0	25,6	78,0	30,7
PN(kg)	NW(LB)	REF.(CODE)	PTOS (PT)		
8,0	17,6	30100161	342		



Sillón relax modelo Edson. Estructura en teca de primera calidad y textilene **Batyline** color negro. Herrajes en acabado inox. Requiere montaje.



AA(cm)	SH(IN)	AB(cm)	AH(IN)	AE(cm)	FH(IN)
35,0	13,8	58,0	22,8	69,0	27,2
PN(kg)	NW(LB)	REF.(CODE)	PTOS (PT)		
9,0	19,8	30100148	350		



Sillón relax modelo Edson. Estructura en teca de primera calidad y textilene **Batyline** color blanco. Herrajes en acabado inox. Requiere montaje.



AA(cm)	SH(IN)	AB(cm)	AH(IN)	AE(cm)	FH(IN)
35,0	13,8	58,0	22,8	69,0	27,2
PN(kg)	NW(LB)	REF.(CODE)	PTOS (PT)		
9,0	19,8	30100162	350		



Taburete alto modelo Edson. Estructura en teca de primera calidad y textilene **Batyline** color negro. Herrajes en acabado inox. Requiere montaje.



AA(cm)	SH(IN)	AB(cm)	AH(IN)	AE(cm)	FH(IN)
79,0	31,1	101,0	39,8	112,0	44,1
PN(kg)	NW(LB)	REF.(CODE)	PTOS (PT)		
10,5	23,1	30100149	392		



Taburete alto modelo Edson. Estructura en teca de primera calidad y textilene **Batyline** color blanco. Herrajes en acabado inox. Requiere montaje.



AA(cm)	SH(IN)	AB(cm)	AH(IN)	AE(cm)	FH(IN)
79,0	31,1	101,0	39,8	112,0	44,1
PN(kg)	NW(LB)	REF.(CODE)	PTOS (PT)		
10,5	23,1	30100163	392		



Tumbona plegable modelo Edson. Estructura en teca de primera calidad y textilene **Batyline** color negro. Herrajes en acabado inox.

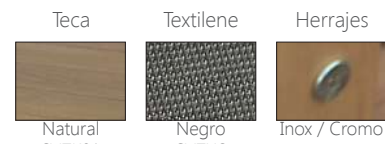

AA(cm)	SH(IN)	AR(cm)	BH(IN)	AB(cm)	AA(IN)
49,0	19,3	82,0	32,3		
PN(kg)	NW(Lb)	REF.(CODE)	PTOS (PT)		
13,0	28,7	30100154	330		



Tumbona plegable modelo Edson. Estructura en teca de primera calidad y textilene **Batyline** color blanco. Herrajes en acabado inox.



AA(cm)	SH(IN)	AR(cm)	BH(IN)	AB(cm)	AA(IN)
49,0	19,3	82,0	32,3		
PN(kg)	NW(Lb)	REF.(CODE)	PTOS (PT)		
13,0	28,7	30100164	330		



Tumbona Edson. Estructura en teca de primera calidad y textilene **Batyline** color negro. Respaldo regulable con herrajes en acabado inox. Requiere montaje.



AA(cm)	SH(IN)	AR(cm)	BH(IN)	AB(cm)	AA(IN)
31,0	12,2	31/91	12,2/35,8		
PN(kg)	NW(Lb)	REF.(CODE)	PTOS (PT)		
27,5	60,6	30100166	680		



Tumbona Edson. Estructura en teca de primera calidad y textilene **Batyline** color blanco. Respaldo regulable con herrajes en acabado inox. Requiere montaje.



AA(cm)	SH(IN)	AR(cm)	BH(IN)	AB(cm)	AA(IN)
31,0	12,2	31/91	12,2/35,8		
PN(kg)	NW(Lb)	REF.(CODE)	PTOS (PT)		
27,5	60,6	30100165	680		



Mesa auxiliar redonda modelo Edson. Teca de primera calidad con herrajes en acero inoxidable. Requiere montaje.



GT(cm)	TT(IN)	AL(cm)	FH(IN)
2,5	1,0	44,0	17,3
PN(kg)	NW(Lb)	REF.(CODE)	PTOS (PT)
18,0	39,7	30100200	418



Mesa de comedor redonda modelo Edson. Teca de primera calidad con herrajes en acero inoxidable. Requiere montaje.

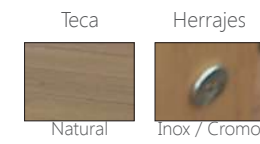

GT(cm)	TT(IN)	AL(cm)	FH(IN)
2,5	1,0	68,0	26,8
PN(kg)	NW(Lb)	REF.(CODE)	PTOS (PT)
19,0	41,9	30100126	440



Mesa bar alta modelo Edson. Teca de primera calidad con herrajes en acero inoxidable. Requiere montaje.



GT(cm)	TT(IN)	AL(cm)	FH(IN)
2,5	1,0	102,0	40,2
PN(kg)	NW(Lb)	REF.(CODE)	PTOS (PT)
28,0	61,7	30100145	920



Silla de comedor modelo Vernom. Teca de primera calidad con herrajes en acero inoxidable. Requiere montaje.

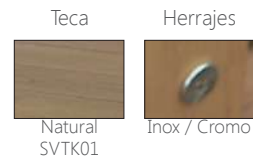

AA(cm)	SH(IN)	AB(cm)	AH(IN)	AE(cm)	FH(IN)
44,0	17,3	66,0	26,0	73,5	28,9
PN(kg)	NW(LB)	REF.(CODE)	PTOS (PT)		
13,0	28,7	30100137	252		



Sofá de una plaza modelo Vernom. Teca de primera calidad con herrajes en acero inoxidable. Cojinería de asiento(14cm) y respaldo(17cm) color crudo. Requiere montaje.



AA(cm)	SH(IN)	AB(cm)	AH(IN)	AE(cm)	FH(IN)
44,0	17,3	64,0	25,2	64,0	25,2
PN(kg)	NW(LB)	REF.(CODE)	PTOS (PT)		
23,2	51,1	30100132	620		



Sofá de dos plazas modelo Vernom. Teca de primera calidad con herrajes en acero inoxidable. Cojinería de asiento(14cm) y respaldo(17cm) color crudo. Requiere montaje.



AA(cm)	SH(IN)	AB(cm)	AH(IN)	AE(cm)	FH(IN)
44,0	17,3	64,0	25,2	64,0	25,2
PN(kg)	NW(LB)	REF.(CODE)	PTOS (PT)		
32,4	71,4	30100133	1250		



Sofá de tres plazas modelo Vernom. Teca de primera calidad con herrajes en acero inoxidable. Cojinería de asiento(14cm) y respaldo(17cm) color crudo. Requiere montaje.



AA(cm)	SH(IN)	AB(cm)	AH(IN)	AE(cm)	FH(IN)
44,0	17,3	64,0	25,2	64,0	25,2
PN(kg)	NW(LB)	REF.(CODE)	PTOS (PT)		
45,6	100,5	30100134	1712		



Modulo de esquina modelo Vernom. Teca de primera calidad con herrajes en acero inoxidable. Cojinería de asiento(14cm) y respaldo(17cm) color crudo. Requiere montaje.



AA(cm)	SH(IN)	AB(cm)	AH(IN)	AE(cm)	FH(IN)
44,0	17,3	64,0	25,2	64,0	25,2
PN(kg)	NW(LB)	REF.(CODE)	PTOS (PT)		
25,2	55,6	30100144	846		



Tramo intermedio modelo Vernom. Teca de primera calidad con herrajes en acero inoxidable. Cojinería de asiento(14cm) y respaldo(17cm) color crudo. Requiere montaje.



AA(cm)	SH(IN)	AB(cm)	AH(IN)	AE(cm)	FH(IN)
44,0	17,3			64,0	25,2
PN(kg)	NW(LB)	REF.(CODE)	PTOS (PT)		
30,4	67,0	30100143	1152		



Lounge brazo izquierdo modelo Vernom. Teca de primera calidad con herrajes en acero inoxidable. Cojinería de asiento(14cm) y respaldo(17cm) color crudo. Requiere montaje.

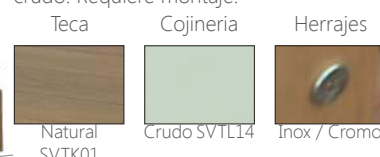

AA(cm)	SH(IN)	AB(cm)	AH(IN)	AE(cm)	FH(IN)
44,0	17,3	64,0	25,2	64,0	25,2
PN(kg)	NW(LB)	REF.(CODE)	PTOS (PT)		
40,6	89,5	30100141	1240		

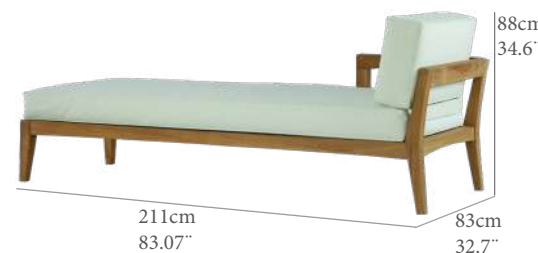

Lounge brazo derecho modelo Vernom. Teca de primera calidad con herrajes en acero inoxidable. Cojinería de asiento(14cm) y respaldo(17cm) color crudo. Requiere montaje.



AA(cm)	SH(IN)	AB(cm)	AH(IN)	AE(cm)	FH(IN)
44,0	17,3	64,0	25,2	64,0	25,2
PN(kg)	NW(LB)	REF.(CODE)	PTOS (PT)		
40,6	89,5	30100142	1240		



Tramo de ampliación modelo Vernom. Teca de primera calidad con herrajes en acero inoxidable. Cojinería de asiento(14cm) y respaldo(17cm) color crudo. Requiere montaje.



AA(cm)	SH(IN)	AB(cm)	AH(IN)	AE(cm)	FH(IN)
44,0	17,3			64,0	25,2
PN(kg)	NW(Lb)	REF.(CODE)	PTOS (PT)		
22,2	48,9	30100210	600		



Modulo brazo izquierdo modelo Vernom. Teca de primera calidad con herrajes en acero inoxidable. Cojinería de asiento(14cm) y respaldo(17cm) color crudo. Requiere montaje.



AA(cm)	SH(IN)	AB(cm)	AH(IN)	AE(cm)	FH(IN)
44,0	17,3	64,0	25,2	64,0	25,2
PN(kg)	NW(Lb)	REF.(CODE)	PTOS (PT)		
23,2	51,1	30100211	600		



Modulo brazo derecho modelo Vernom. Teca de primera calidad con herrajes en acero inoxidable. Cojinería de asiento(14cm) y respaldo(17cm) color crudo. Requiere montaje.



AA(cm)	SH(IN)	AB(cm)	AH(IN)	AE(cm)	FH(IN)
44,0	17,3	64,0	25,2	64,0	25,2
PN(kg)	NW(Lb)	REF.(CODE)	PTOS (PT)		
23,2	51,1	30100212	600		

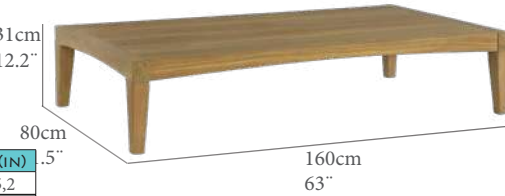

Mesa auxiliar modelo Vernom. Teca de primera calidad con herrajes en acero inoxidable. Cojinería de asiento(14cm) y respaldo(17cm) color crudo. Requiere montaje.

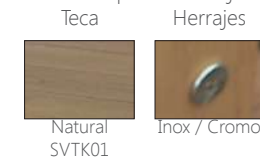

GT(cm)	TT(IN)	AL(cm)	FH(IN)
2,5	1,0	24,0	9,4
PN(kg)	NW(Lb)	REF.(CODE)	PTOS (PT)
10,0	22,0	30100135	554



Mesa de comedor extensible modelo Vernom. Teca de primera calidad con herrajes en acero inoxidable. Guías correderas en acero inox. Requiere montaje.



GT(cm)	TT(IN)	AL(cm)	FH(IN)
2,5	1,0	68	26,8
PN(kg)	NW(Lb)	REF.(CODE)	PTOS (PT)
85,0	187,4	30100136	1698



Tumbona modelo Vernom. Teca de primera calidad con herrajes en acero inoxidable. Respaldo regulable en 4 posiciones. Cojinería (6cm) opcional. Requiere montaje.



AA(cm)	SH(IN)	AR(cm)	BH(IN)	AB(cm)	AA(IN)
31,0	12,2	31/91	12,2/35,8		
PN(kg)	NW(Lb)	REF.(CODE)	PTOS (PT)		
25,0	55,1	30100130	448		

Cojín para tumbona Vernom.

PN(kg)	NW(Lb)	REF.(CODE)	PTOS (PT)
4,0	8,8	30400089	252



Composición Vernom 6 piezas:

- 1 Lounge brazo (R). Referencia 30100142
- 1 Tramo intermedio. Referencia 30100143
- 1 Mod. Ampliación. Referencia 30100210
- Mod. Esquinero. Referencia 30100144
- 1 Mod. Brazo (L). Referencia 30100211
- 1 Mesa auxiliar. Referencia 30100135



Composición Vernom 4 piezas:

- 1 mesa auxiliar. Referencia 30100135
- 2 Sofá una plaza. Referencia 30100132
- 1 Sofá tres plazas. Referencia 30100134



Silla de comedor Básica. Estructura en teca de primera calidad. **Cojinería (4cm) opcional.** Plegable.



AA(cm)	SH(IN)	AB(cm)	AH(IN)	AE(cm)	FH(IN)
45,0	17,7			91,0	35,8
PN(kg)	NW(LB)	REF.(CODE)		PTOS (PT)	
6,5	14,3	30100038		78	

Cojín para silla básica color crudo.

PN(kg)	NW(LB)	REF.(CODE)	PTOS (PT)
1,3	2,9	30400084	130



Silla de comedor Básica con brazos. Estructura en teca de primera calidad. Herrajes terminación latón / Inox. **Cojinería (4cm) opcional.** Plegable.



AA(cm)	SH(IN)	AB(cm)	AH(IN)	AE(cm)	FH(IN)
45,0	17,7	64,0	25,2	91,0	35,8
PN(kg)	NW(LB)	REF.(CODE)		PTOS (PT)	
8,0	17,6	30100039		126	

Cojín para silla básica color crudo.

PN(kg)	NW(LB)	REF.(CODE)	PTOS (PT)
1,3	2,9	30400084	130



Silla de comedor Sunny. Estructura en teca de primera calidad. **Cojinería (4cm) opcional.** Plegable.



AA(cm)	SH(IN)	AB(cm)	AH(IN)	AE(cm)	FH(IN)
46,0	18,1			98,0	38,6
PN(kg)	NW(LB)	REF.(CODE)		PTOS (PT)	
8,0	17,6	30100100		104	

Cojín para silla Sunny color crudo.

PN(kg)	NW(LB)	REF.(CODE)	PTOS (PT)
1,4	3,1	30400085	130



Silla de comedor Sunny con brazos. Estructura en teca de primera calidad. Herrajes terminación latón / Inox. **Cojinería (4cm) opcional.** Plegable.

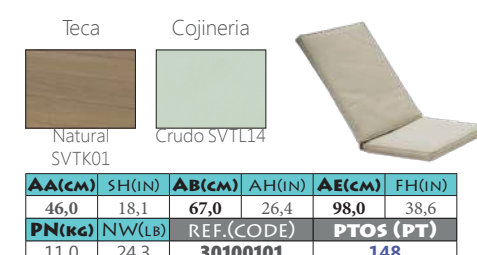

AA(cm)	SH(IN)	AB(cm)	AH(IN)	AE(cm)	FH(IN)
46,0	18,1	67,0	26,4	98,0	38,6
PN(kg)	NW(LB)	REF.(CODE)		PTOS (PT)	
11,0	24,3	30100101		148	

Cojín para silla Sunny color crudo.

PN(kg)	NW(LB)	REF.(CODE)	PTOS (PT)
1,4	3,1	30400085	130



Sillón reclinable en 4 posiciones modelo Bali. Estructura en teca de primera calidad. Herrajes en Latón / Inox. **Cojinería (6cm) opcional.** Plegable.



AA(cm)	SH(IN)	AR(cm)	BH(IN)	AB(cm)	AA(IN)
44,0	17,3	80/106	31,5-41,7	69,5	27,4
PN(kg)	NW(LB)	REF.(CODE)		PTOS (PT)	
12,0	26,5	30100079		256	

Cojín para sillón Bali color crudo.

PN(kg)	NW(LB)	REF.(CODE)	PTOS (PT)
2,4	5,3	30400086	184



Sillón reclinable en 4 posiciones modelo Buckingham. Estructura en teca de primera calidad. Herrajes en Latón / Inox. **Cojinería (6cm) opcional.** Plegable.



AA(cm)	SH(IN)	AR(cm)	BH(IN)	AB(cm)	AA(IN)
46,0	18,1	82,5/110	32,5-43,3	72,0	28,3
PN(kg)	NW(LB)	REF.(CODE)		PTOS (PT)	
13,0	28,7	30100077		256	

Cojín para sillón Buckingham color crudo.

PN(kg)	NW(LB)	REF.(CODE)	PTOS (PT)
2,4	5,3	30400087	184



Mesa auxiliar redonda modelo Edson. Teca de primera calidad con herrajes en acero inoxidable. Requiere montaje.

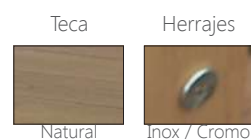

GT(cm)	TT(IN)	AL(cm)	FH(IN)
2,5	1,0	37,0	14,6
PN(kg)	NW(LB)	REF.(CODE)	PTOS (PT)
18,0	39,7	30100200	418



Mesa Auxiliar cuadrada plegable. Estructura en teca de primera calidad. Sistema de plegado fácil.

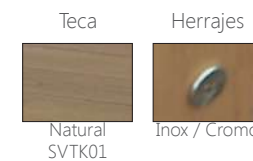

GT(cm)	TT(IN)	AL(cm)	FH(IN)
2,5	1,0	42,5	16,7
PN(kg)	NW(LB)	REF.(CODE)	PTOS (PT)
6,5	14,3	30100115	136

Mesa Auxiliar cuadrada. Estructura en teca de primera calidad. Requiere montaje.

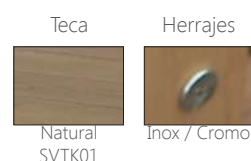

GT(cm)	TT(IN)	AL(cm)	FH(IN)
2,5	1,0	37,0	14,6
PN(kg)	NW(LB)	REF.(CODE)	PTOS (PT)
7,0	15,4	30100064	120



Mesa Auxiliar rectangular. Estructura en teca de primera calidad. Requiere montaje.

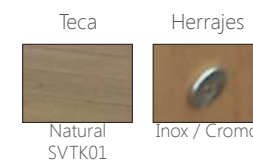

GT(cm)	TT(IN)	AL(cm)	FH(IN)
2,5	1,0	37,0	14,6
PN(kg)	NW(LB)	REF.(CODE)	PTOS (PT)
11,0	24,3	30100066	174

Mesa Auxiliar rectangular. Estructura en teca de primera calidad. Requiere montaje.

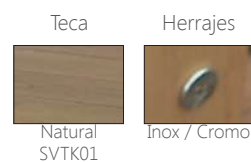

GT(cm)	TT(IN)	AL(cm)	FH(IN)
2,5	1,0	40,0	15,7
PN(kg)	NW(LB)	REF.(CODE)	PTOS (PT)
17,0	37,5	30100065	244

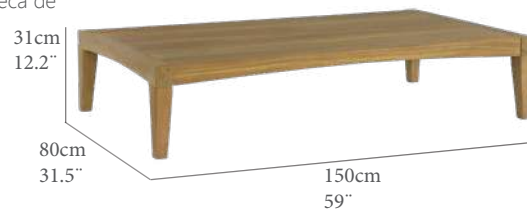

Mesa auxiliar modelo Vernom. Teca de primera calidad con herrajes en acero inoxidable. Requiere montaje.



GT(cm)	TT(IN)	AL(cm)	FH(IN)
2,5	1,0	32,0	12,6
PN(kg)	NW(LB)	REF.(CODE)	PTOS (PT)
10,0	22,0	30100135	554

Mesa auxiliar Nirea. Teca de primera calidad con herrajes en acero inoxidable. Requiere montaje.

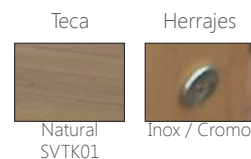
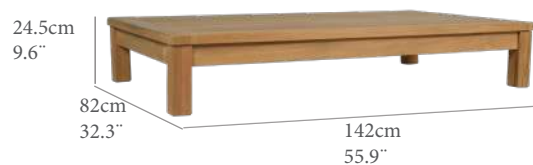

GT(cm)	TT(IN)	AL(cm)	FH(IN)
2,5	1,0	14,5	5,7
PN(kg)	NW(LB)	REF.(CODE)	PTOS (PT)
27,0	59,5	30100169	458

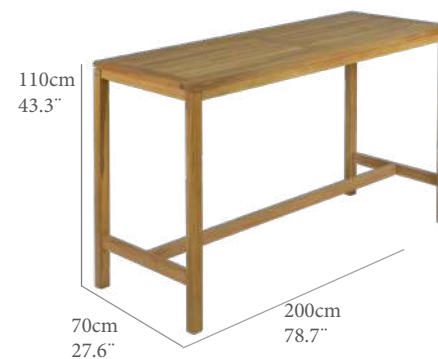

Mesa bar alta modelo Edson. Teca de primera calidad con herrajes en acero inoxidable. Requiere montaje.



GT(cm)	TT(IN)	AL(cm)	FH(IN)
2,5	1,0	102,0	40,2
PN(kg)	NW(LB)	REF.(CODE)	PTOS (PT)
28,0	61,7	30100145	920

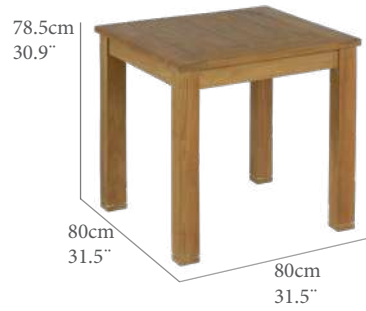

Mesa rustica cuadrada modelo Vernom. Teca de primera calidad con herrajes en acero inoxidable. Requiere montaje.

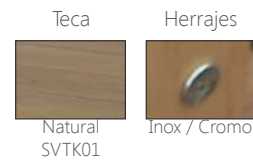

GT(cm)	TT(IN)	AL(cm)	FH(IN)
2,5	1,0	68,0	26,8
PN(kg)	NW(LB)	REF.(CODE)	PTOS (PT)
25,0	55,1	30100124	490

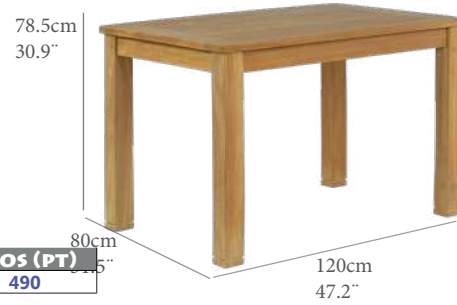

Mesa rustica rectangular modelo Vernom. Teca de primera calidad con herrajes en acero inoxidable. Requiere montaje.

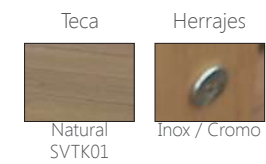

GT(cm)	TT(IN)	AL(cm)	FH(IN)
2,5	1,0	68,0	26,8
PN(kg)	NW(LB)	REF.(CODE)	PTOS (PT)
28,0	61,7	30100123	532



Mesa rustica modelo Vernom. Teca de primera calidad con herrajes en acero inoxidable. Requiere montaje.

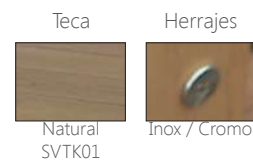

GT(cm)	TT(IN)	AL(cm)	FH(IN)
2,5	1,0	68,0	26,8
PN(kg)	NW(LB)	REF.(CODE)	PTOS (PT)
59,0	130,1	30100114	1050



Mesa rustica modelo Vernom. Teca de primera calidad con herrajes en acero inoxidable. Requiere montaje.



GT(cm)	TT(IN)	AL(cm)	FH(IN)
2,5	1,0	68,0	26,8
PN(kg)	NW(LB)	REF.(CODE)	PTOS (PT)
74,0	163,1	30100102	1332



Mesa de comedor redonda modelo Edson. Teca de primera calidad con herrajes en acero inoxidable. Requiere montaje.

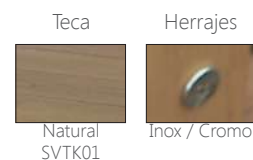

GT(cm)	TT(IN)	AL(cm)	FH(IN)
2,5	1,0	68,0	26,8
PN(kg)	NW(LB)	REF.(CODE)	PTOS (PT)
19,0	41,9	30100126	440



Mesa de comedor **extensible** modelo Vernom. Teca de primera calidad con herrajes en acero inoxidable. Guías correderas en acero inoxidable. Requiere montaje.



GT(cm)	TT(IN)	AL(cm)	FH(IN)
2,5	1,0	68,0	26,8
PN(kg)	NW(LB)	REF.(CODE)	PTOS (PT)
85,0	187,4	30100136	1698



Mesa octogonal **extensible**. Estructura en madera de teca de primera calidad. Sistema de extensión central con apertura simple. Requiere montaje.



GT(cm)	TT(IN)	AL(cm)	FH(IN)
2,5	1,0	61,0	24,0
PN(kg)	NW(LB)	REF.(CODE)	PTOS (PT)
39,0	86,0	30100067	688



Mesa redonda **extensible**. Estructura en madera de teca de primera calidad. Sistema de extensión central con apertura simple. Requiere montaje.



GT(cm)	TT(IN)	AL(cm)	FH(IN)
2,5	1,0	61,0	24,0
PN(kg)	NW(LB)	REF.(CODE)	PTOS (PT)
39,0	86,0	30100074	582



Mesa rectangular **extensible**. Estructura en madera de teca de primera calidad. Sistema de extensión central con apertura simple. Requiere montaje.



GT(cm)	TT(IN)	AL(cm)	FH(IN)
2,5	1,0	61,0	24,0
PN(kg)	NW(LB)	REF.(CODE)	PTOS (PT)
51,0	112,4	30100023	694



Mesa rectangular **extensible**. Estructura en madera de teca de primera calidad. Sistema de extensión central con apertura simple. Requiere montaje.



GT(cm)	TT(IN)	AL(cm)	FH(IN)
2,5	1,0	61,0	24,0
PN(kg)	NW(LB)	REF.(CODE)	PTOS (PT)
56,0	123,5	30100019	896



Mesa rectangular **extensible**. Estructura en madera de teca de primera calidad. Sistema de extensión central con apertura simple. Requiere montaje.



GT(cm)	TT(IN)	AL(cm)	FH(IN)
2,5	1,0	61,0	24,0
PN(kg)	NW(LB)	REF.(CODE)	PTOS (PT)
58,0	127,9	30100070	896



Mesa oval **extensible**. Estructura en madera de teca de primera calidad. Sistema de extensión central con apertura simple. Requiere montaje.



GT(cm)	TT(IN)	AL(cm)	FH(IN)
2,5	1,0	61,0	24,0
PN(kg)	NW(LB)	REF.(CODE)	PTOS (PT)
69,0	152,1	30100068	720



Mesa oval **extensible**. Estructura en madera de teca de primera calidad. Sistema de extensión central con apertura doble. Requiere montaje.



GT(cm)	TT(IN)	AL(cm)	FH(IN)
2,5	1,0	61,0	24,0
PN(kg)	NW(LB)	REF.(CODE)	PTOS (PT)
53,0	116,8	30100069	920



Mesa oval **extensible**. Estructura en madera de teca de primera calidad. Sistema de extensión central con apertura doble. Requiere montaje.



GT(cm)	TT(IN)	AL(cm)	FH(IN)
2,5	1,0	61,0	24,0
PN(kg)	NW(LB)	REF.(CODE)	PTOS (PT)
56,0	123,5	30100091	1226



Conjunto formado por mesa redonda **plegable** Ø60cm + 2 sillas plegables.



AA(cm)	SH(IN)	AL(cm)	TH(IN)	AE(cm)	FH(IN)
45,0	17,7	72,5	28,5	91,0	35,8
PN(kg)	NW(Lb)	REF.(CODE)	PTOS (PT)		
19,0	41,9	30100117	316		



Conjunto formado por mesa redonda **plegable** Ø80cm + 2 sillas plegables.



AA(cm)	SH(IN)	AL(cm)	TH(IN)	AE(cm)	FH(IN)
45,0	17,7	72,5	28,5	91,0	35,8
PN(kg)	NW(Lb)	REF.(CODE)	PTOS (PT)		
25,0	55,1	30100048	326		



Conjunto formado por mesa octogonal **plegable** Ø70cm + 2 sillas plegables.



AA(cm)	SH(IN)	AL(cm)	TH(IN)	AE(cm)	FH(IN)
45,0	17,7	72,5	28,5	91,0	35,8
PN(kg)	NW(Lb)	REF.(CODE)	PTOS (PT)		
25,0	55,1	30100075	326		



Conjunto formado por mesa cuadrada **plegable** 70 x 70cm + 2 sillas plegables.



AA(cm)	SH(IN)	AL(cm)	TH(IN)	AE(cm)	FH(IN)
45,0	17,7	72,5	28,5	91,0	35,8
PN(kg)	NW(Lb)	REF.(CODE)	PTOS (PT)		
25,0	55,1	30100109	326		



Conjunto formado por mesa rectangular **plegable** 120 x 70cm + 4 sillas plegables.



AA(cm)	SH(IN)	AL(cm)	TH(IN)	AE(cm)	FH(IN)
45,0	17,7	72,5	28,5	91,0	35,8
PN(kg)	NW(Lb)	REF.(CODE)	PTOS (PT)		
40,0	88,2	30100110	556		



Conjunto formado por mesa redonda **plegable** Ø100 + 4 sillas plegables.



AA(cm)	SH(IN)	AL(cm)	TH(IN)	AE(cm)	FH(IN)
45,0	17,7	72,5	28,5	91,0	35,8
PN(kg)	NW(Lb)	REF.(CODE)	PTOS (PT)		
40,0	88,2	30100122	530		



Conjunto formado por mesa octogonal **plegable** Ø120 + 4 sillas plegables.



AA(cm)	SH(IN)	AL(cm)	TH(IN)	AE(cm)	FH(IN)
45,0	17,7	72,5	28,5	91,0	35,8
PN(kg)	NW(Lb)	REF.(CODE)	PTOS (PT)		
47,0	103,6	30100047	564		



Conjunto formado por mesa redonda **plegable** Ø120 + 4 sillas plegables.



AA(cm)	SH(IN)	AL(cm)	TH(IN)	AE(cm)	FH(IN)
45,0	17,7	72,5	28,5	91,0	35,8
PN(kg)	NW(Lb)	REF.(CODE)	PTOS (PT)		
47,0	103,6	30100116	564		



Mesa redonda plegable. Teca de primera calidad terminación natural. **Sistema de plegado fácil.**



GT(cm)	TT(IN)	AL(cm)	FH(IN)
2,5	1,0	72,5	28,5
PN(kg)	NW(LB)	REF.(CODE)	PTOS (PT)
6,0	13,2	30100073	160



Mesa redonda plegable. Teca de primera calidad terminación natural. **Sistema de plegado fácil.**



GT(cm)	TT(IN)	AL(cm)	FH(IN)
2,5	1,0	72,5	28,5
PN(kg)	NW(LB)	REF.(CODE)	PTOS (PT)
12,0	26,5	30100009	170



Mesa cuadrada plegable. Teca de primera calidad terminación natural. **Sistema de plegado fácil.**



GT(cm)	TT(IN)	AL(cm)	FH(IN)
2,5	1,0	72,5	28,5
PN(kg)	NW(LB)	REF.(CODE)	PTOS (PT)
12,0	26,5	30100096	170



Mesa octogonal plegable. Teca de primera calidad terminación natural. **Sistema de plegado fácil.**



GT(cm)	TT(IN)	AL(cm)	FH(IN)
2,5	1,0	72,5	28,5
PN(kg)	NW(LB)	REF.(CODE)	PTOS (PT)
12,0	26,5	30100082	170



Mesa rectangular plegable. Teca de primera calidad terminación natural. **Sistema de plegado fácil.**



GT(cm)	TT(IN)	AL(cm)	FH(IN)
2,5	1,0	72,5	28,5
PN(kg)	NW(LB)	REF.(CODE)	PTOS (PT)
15,0	33,1	30100060	244



Mesa redonda plegable. Teca de primera calidad terminación natural. **Sistema de plegado fácil.**



GT(cm)	TT(IN)	AL(cm)	FH(IN)
2,5	1,0	72,5	28,5
PN(kg)	NW(LB)	REF.(CODE)	PTOS (PT)
14,0	30,9	30100118	218



Mesa octogonal plegable. Teca de primera calidad terminación natural. **Sistema de plegado fácil.**



GT(cm)	TT(IN)	AL(cm)	FH(IN)
2,5	1,0	72,5	28,5
PN(kg)	NW(LB)	REF.(CODE)	PTOS (PT)
21,0	46,3	30100095	252



Mesa redonda plegable. Teca de primera calidad terminación natural. **Sistema de plegado fácil.**



GT(cm)	TT(IN)	AL(cm)	FH(IN)
2,5	1,0	72,5	28,5
PN(kg)	NW(LB)	REF.(CODE)	PTOS (PT)
22,0	48,5	30100010	252



Carro bar de teca. Estructura en teca de primera calidad. Con dos bandejas y porta-bebidas. Ruedas de transporte.

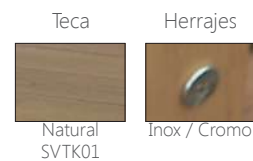

PN(KG)	NW(LB)	REF.(CODE)	PTOS (PT)
13,0	28,7	30600050	246



Mesa redonda con alas plegable. Estructura en teca de primera calidad. Sistema de plegado fácil.

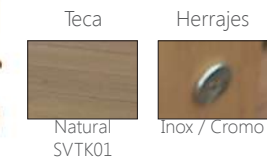

GT(CM)	TT(IN)	AL(CM)	FH(IN)
2,5	1,0	72,5	28,5
PN(KG)	NW(LB)	REF.(CODE)	PTOS (PT)
24,0	52,9	30100072	458

Medida plegada: 120 X 81 X 20 cm.



Taburete alto plegable. Estructura en teca de primera calidad. Herrajes en acabado inox. Requiere montaje.

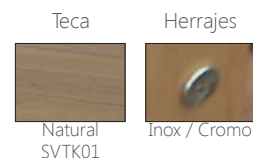

AA(CM)	SH(IN)	AB(CM)	AH(IN)	AE(CM)	FH(IN)
75,0	29,5			115,0	45,3
PN(KG)	NW(LB)	REF.(CODE)	PTOS (PT)		
8,0	17,6	30100111	188		



Barra de bar. Estructura en teca de primera calidad. Encimera y laterales plegables con sistema de cierre. Dispone de sistema de cierre y sistema de almacenaje y organización interior.



PN(KG)	NW(LB)	REF.(CODE)	PTOS (PT)
47,0	103,6	30600053	592

Medida plegada: 95 X 54 X 110 cm.



Tumbona modelo Presidencial. Teca de primera calidad con herrajes en latón. Respaldo multiposiciones. Cojinería (6cm) opcional. Plegable.



AA(CM)	SH(IN)	AR(CM)	BH(IN)	AB(CM)	AA(IN)
37,0	14,6	80-98	31,5-38,6	60,0	23,6
PN(KG)	NW(LB)	REF.(CODE)	PTOS (PT)		
17,0	37,5	30100078	314		

Cojín para tumbona Presidencial.

PN(KG)	NW(LB)	REF.(CODE)	PTOS (PT)
3,0	6,6	30400070	176



Tumbona modelo Banf. Teca de primera calidad con herrajes en latón. Se compone de dos piezas (Sillón + reposapiés). Cojinería (6cm) opcional. Requiere montaje.



AA(CM)	SH(IN)	AR(CM)	BH(IN)	AB(CM)	AA(IN)
37,0	14,6	87,0	34,3	60,0	23,6
PN(KG)	NW(LB)	REF.(CODE)	PTOS (PT)		
21,0	46,3	30100131	583		

Cojín para tumbona Banf.

PN(KG)	NW(LB)	REF.(CODE)	PTOS (PT)
3,6	7,9	30400088	250



Tumbona modelo Laguna. Teca de primera calidad con herrajes en latón. Respaldo y reposapiés regulables en 4 posiciones. Con bandeja extraíble. Cojinería (6cm) opcional. Requiere montaje.



AA(CM)	SH(IN)	AR(CM)	BH(IN)	AB(CM)	AA(IN)
33,5	13,2	33,5/91	13,2/35,8		
PN(KG)	NW(LB)	REF.(CODE)	PTOS (PT)		
30,0	66,1	30100081	532		

Cojín para tumbona Laguna

PN(KG)	NW(LB)	REF.(CODE)	PTOS (PT)
4,0	8,8	30400069	252



Tumbona modelo Vernom. Teca de primera calidad con herrajes en acero inoxidable. Respaldo regulable en 4 posiciones. Cojinería (6cm) opcional. Requiere montaje.



AA(CM)	SH(IN)	AR(CM)	BH(IN)	AB(CM)	AA(IN)
31,0	12,2	31/91	12,2/35,8		
PN(KG)	NW(LB)	REF.(CODE)	PTOS (PT)		
25,0	55,1	30100130	448		

Cojín para tumbona Vernom.

PN(KG)	NW(LB)	REF.(CODE)	PTOS (PT)
4,0	8,8	30400089	252

COLECCIÓN ALUMINIO / ALUMINIUM COLLECTION

Aluminio

Blanco SVAL1

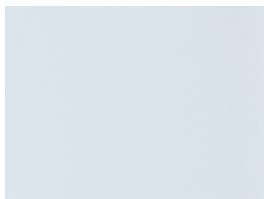

Arce SVAL2



Taupe SVAL3



Antracita SVAL4



Aguamarina SVAL5



Verde Oliva SVAL6



Textilene

Blanco SVTX1



Gris Claro SVTX2

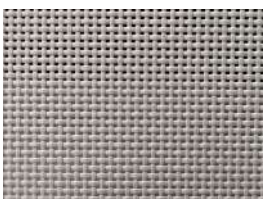

Arce SVTX3



Gris Antra SVTX4

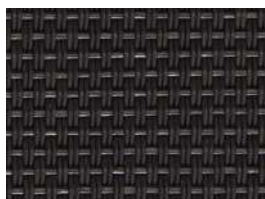

Taupe SVTX5



Cuerda

Olefina gris claro SVCR01



Olefina Taupe SVCR02



Olefina antracita SVCR03



Textil

Gris claro SVTL05

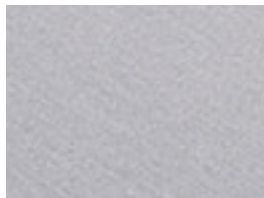

Taupe SVTL07

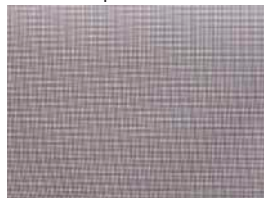

Gris tempo SVTX09



Nautico blanco SVTL01



Blanco cartenza SVTL02



Arce cartenza SVTL03



Blanco Stryn SVTL11



Gris Stryn SVTL12

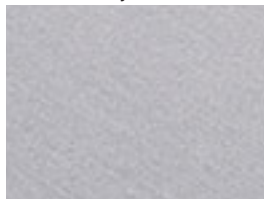

Blanco SVTL04



Gris claro SVTL05



Gris claro B SVTL20



Cristal

Blanco SVCT01

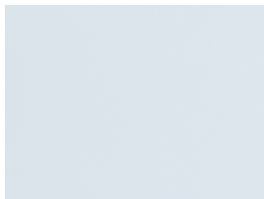

Arce SVCT02

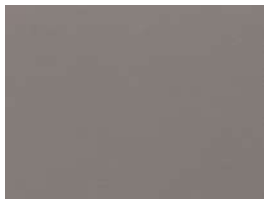

Taupe SVCT03



Gris claro SVCT05



Greywood SVCT05



Antracita SVCT06

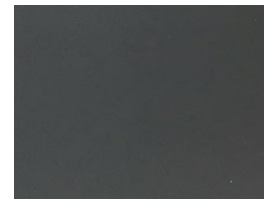

Cerámico Granit SVCT10



Polywood

Gris SVPW01



Cuerda

Antracita SVCR04



Gris SVCR05

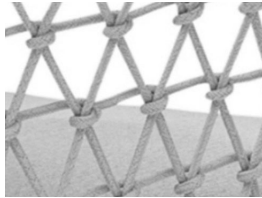

Gris acero SVCR06



Antracita SVCR07

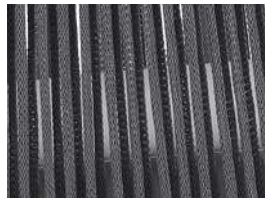

Greige SVCR11

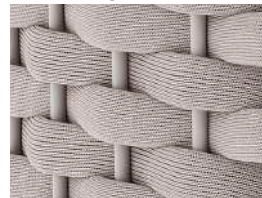

Blanca (G.hind)



TAupe SVCR08

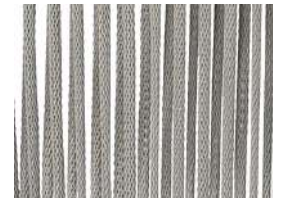

Blanco SVCR10



Gris claro SVCR09



Aluminio

Gris antracita SVAL04



Light grey SVAL08



Blanco SVAL1

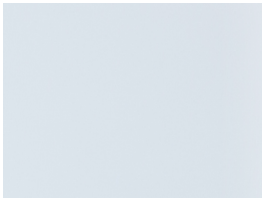

Greige SVAL09



Taupe SVAL03



Cristal

Ceramic antracita SVCT11"



Blanco SVCT01

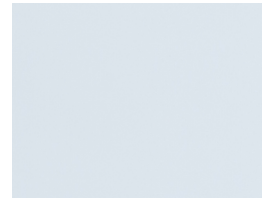

Ceram. Blanco SVCT14"

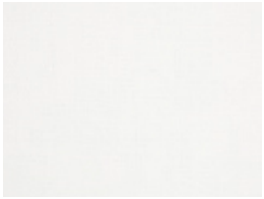

Ceramic SVCT12"



Ceramic "Granit" SVCT13



Antracita SVCT06



Old marbre SVCT16

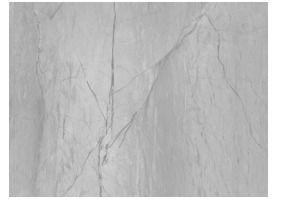

Gris acero SVCT15



Textil

Gris medio SVTL21



Gris claro SVTL22



Gris Jaspeado A SVTL25



Gris Jaspeado B SVTL23



Gris Profundo SVTL24

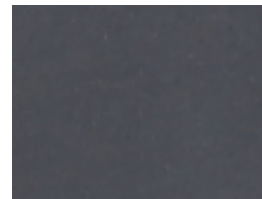

Gris claro SVTL20



Gris claro SVTL32



Marine grey SVTL31

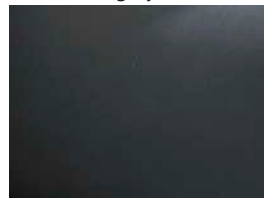

Taupe SVTL26



Gris medio SVTL27



Gris acero SVTL28



Gris amatista SVTL229



Gris fluorita SVTL30

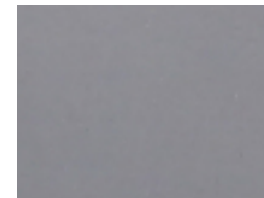





Condiciones Generales de Venta

Condiciones de envío: Portes pagados en pedidos superiores a 450€ netos (IVA no incluido) para península y baleares (Salvo Formentera, consultar condiciones). Para pedidos no superiores a 450€ se aplicará un porte fijo de 30€+IVA que incluiremos en albarán por pedido.

Otros países consultar condiciones.

La mercancía se entregará desde nuestros almacenes de Silla (Valencia). Cualquier anomalía deberá ser reclamada a la recepción de la mercancía, y haciéndola constar en el parte del transportista o albarán de recepción **en un plazo máximo de 24 horas**. Dicha incidencia se comunicará a Sunnyval garden & contract (Coval maquinaria S.A.) inmediatamente. De no ser así, Coval se exime de toda responsabilidad por daños de transporte. No se aceptará ninguna reclamación causada por transporte sin fotografías de la incidencia y del embalaje en mal estado.

Las entregas realizadas fuera de las instalaciones habituales de entrega, siempre se realizarán a pie de calle, y se aplicará un recargo del 5% en el precio tarifa del producto.

Devolución de mercancía: Cualquier devolución deberá ser aceptada previamente por Coval. En un plazo que no exceda los 30 días, se admitirán devoluciones de artículos no usados ni montados y únicamente en su embalaje original. **Los gastos de devolución serán a cargo del cliente.** En ningún caso se aceptará la devolución de muebles cuyo montaje haya sido iniciado. Al producirse las devoluciones Coval emitirá un albarán de abono que se liquidará en próximas facturas.

Garantía general del producto: La garantía General de todos los productos del catálogo es de **3 años** desde la fecha de entrega al usuario final. La garantía solo cubre defectos de fabricación y no del uso o desgaste normal del producto así como de su mala utilización o falta de protección a condiciones climatológicas extremas o periodos prolongados de desuso.

Toda reclamación de garantía deberá ser cursada adjuntando el parte de incidencia y fotos de la misma vía email. Una vez aceptada se recogerá en las instalaciones del cliente siendo los gastos de devolución a cargo de Sunnyval, y pasará a ser reparada por el equipo técnico de Sunnyval. De no ser posible, se procederá al cambio. Coval se reserva el derecho de realizar el cambio directo del artículo en garantía sin proceder a la recogida del artículo defectuoso.

La cojinería de serie incluida en los productos no tiene garantía por decoloración ya que los pigmentos de la tela se aclaran u oscurecen con el paso del tiempo. La cojinería a medida de gama especial cuenta con dos años de garantía frente a decoloración de grado superior al 10%. No se atenderá en garantía la aparición de pequeñas grietas en madera de teca siempre y cuando no afecten a la estructura y seguridad del mueble, siendo la aparición de estas totalmente normal en el tiempo. No se aceptará como garantía muebles de wicker con fibras rotas los cuales no hayan sido debidamente protegidos en periodos prolongados de desuso.

Tarifa válida salvo error tipográfico. Nos reservamos el derecho a introducir modificaciones en el diseño o en los precios de este catálogo. Imágenes cedidas por los fabricantes de producto. En base a las imágenes de este catálogo no se pueden hacer valer derechos. Precios válidos hasta fin de existencias o actualización de tarifa. Algunos datos técnicos son aproximados.

Ante cualquier controversia, los tribunales competentes serán los de Valencia. **ENERO 2024**



Terms of Sale

Shipping terms: Freight paid on orders over € 450 net (VAT not included) for the peninsula and the Balearic Islands (Except Formentera, check terms). For orders not exceeding € 450 a fixed charge of € 30 + VAT will be applied that we will include on the delivery note.

Other countries consult terms

The merchandise will be delivered from our warehouses in Silla (Valencia). Any anomaly must be claimed upon receipt of the merchandise, and stating it on the part of the carrier or receipt within a maximum period of 24 hours. Said incident will be communicated to Sunnyval garden & contract (Coval Maquinaria S.A.) immediately. If not, Coval disclaims all liability for transport damage. Any claim caused by transport without photographs of the incident and of the packaging in poor condition will not be accepted.

Return of merchandise: Any return must be previously accepted by Coval. In a period not exceeding 30 days, returns of items not used or assembled and in their original packaging will be accepted. The return costs will be borne by the customer. In no case will the return of furniture whose assembly has been initiated be accepted. When the returns are made, Coval will issue a credit invoice that will be settled in future invoices.

Deliveries made outside of a customer's usual delivery facilities will always be made at street level, and will incur a 5% surcharge in the price of the product.

General guarantee of the product: The General guarantee of all products in the catalog is 3 years from the date of delivery to the end user. The guarantee only covers manufacturing defects and not the normal use or wear of the product as well as its bad use or lack of protection to extreme weather conditions or prolonged periods of disuse.

All warranty claims must be submitted attaching the incident and photos of the same via email. Once accepted, it will be collected at the client's facilities, with the return costs borne by Coval and repaired by the Sunnyval technical team. If this is not possible, we will proceed to the change. Coval reserves the right to make the direct change of the article in warranty without proceeding to the collection of the defective article.

The standard cushion included in the sets is not guaranteed by discoloration since the pigments of the fabric become lighter or darker with the passage of time. The custom-made cushion of special range has a two-year warranty against discoloration of more than 10%. The appearance of small cracks in teak wood will not be taken into warranty as long as they do not affect the structure and safety of the furniture. The appearance of these is totally normal over time. Wicker furniture with broken fibers which have not been properly protected in prolonged periods of disuse will not be accepted as warranty.

Valid prices except typographical error. We reserve the right to make changes to the design or prices of this catalog. Images provided by product manufacturers. No rights can be asserted based on the images in this catalog. Prices valid until end of stock. Some technical data are approximate.

In case of any dispute, the competent courts will be those of Valencia. **JANUARY 2024**

